

SHARP[®]

PN-L401C

LCD MONITOR

OPERATION MANUAL

HDMI

IMPORTANT:

To aid reporting in case of loss or theft, please record the product's model and serial numbers in the space provided. The numbers are located in the rear of the product.



Model No.:

Serial No.:

U.S.A. ONLY

IMPORTANT INFORMATION

WARNING: TO REDUCE THE RISK OF FIRE OR ELECTRIC SHOCK, DO NOT EXPOSE THIS PRODUCT TO RAIN OR MOISTURE.

	CAUTION RISK OF ELECTRIC SHOCK DO NOT OPEN	
CAUTION: TO REDUCE THE RISK OF ELECTRIC SHOCK, DO NOT REMOVE COVER. NO USER-SERVICEABLE PARTS INSIDE. REFER SERVICING TO QUALIFIED SERVICE PERSONNEL.		



The lightning flash with arrowhead symbol, within a triangle, is intended to alert the user to the presence of uninsulated "dangerous voltage" within the product's enclosure that may be of sufficient magnitude to constitute a risk of electric shock to persons.



The exclamation point within a triangle is intended to alert the user to the presence of important operating and maintenance (servicing) instructions in the literature accompanying the product.

WARNING:

FCC Regulations state that any unauthorized changes or modifications to this equipment not expressly approved by the manufacturer could void the user's authority to operate this equipment.

NOTE:

This equipment has been tested and found to comply with the limits for Class A digital device, pursuant to Part 15 of the FCC Rules. These limits are designed to provide reasonable protection against harmful interference when the equipment is operated in a commercial environment. This equipment generates, uses, and can radiate radio frequency energy and, if not installed and used in accordance with the instruction manual, may cause harmful interference to radio communications. Operation of this equipment in a residential area is likely to cause harmful interference in which case the user will be required to correct the interference at his own expense.

U.S.A. ONLY

DEAR SHARP CUSTOMER

Thank you for your purchase of a SHARP LCD product. To ensure safety and many years of trouble-free operation of your product, please read the Safety Precautions carefully before using this product.

SAFETY PRECAUTIONS

Electricity is used to perform many useful functions, but it can also cause personal injuries and property damage if improperly handled. This product has been engineered and manufactured with the highest priority on safety. However, improper use can result in electric shock and/or fire. In order to prevent potential danger, please observe the following instructions when installing, operating and cleaning the product. To ensure your safety and prolong the service life of your LCD product, please read the following precautions carefully before using the product.

1. Read instructions — All operating instructions must be read and understood before the product is operated.
2. Keep this manual in a safe place — These safety and operating instructions must be kept in a safe place for future reference.
3. Observe warnings — All warnings on the product and in the instructions must be observed closely.
4. Follow instructions — All operating instructions must be followed.
5. Cleaning — Unplug the power cord from the AC outlet before cleaning the product. Use a dry cloth to clean the product. Do not use liquid cleaners or aerosol cleaners. Do not use dirty cloths. Doing so may damage the product.
6. Attachments — Do not use attachments not recommended by the manufacturer. Use of inadequate attachments can result in accidents.
7. Water and moisture — Do not use the product near water. Do not install the product in a place where water may splash onto it. Be careful of equipment which drains water such as an air-conditioner.
8. Ventilation — The vents and other openings in the cabinet are designed for ventilation. Do not cover or block these vents and openings since insufficient ventilation can cause overheating and/or shorten the life of the product. Do not place the product on a sofa, rug or other similar surface, since they can block ventilation openings. Do not place the product in an enclosed place such as a bookcase or rack, unless proper ventilation is provided or the manufacturer's instructions are followed.
9. Power cord protection — The power cords must be routed properly to prevent people from stepping on them or objects from resting on them.
10. The screen used in this product is made of glass. Therefore, it can break when the product is dropped or applied with impact. Be careful not to be injured by broken glass pieces in case the screen breaks.
11. Overloading — Do not overload AC outlets or extension cords. Overloading can cause fire or electric shock.
12. Entering of objects and liquids — Never insert an object into the product through vents or openings. High voltage flows in the product, and inserting an object can cause electric shock and/or short internal parts. For the same reason, do not spill water or liquid on the product.
13. Servicing — Do not attempt to service the product yourself. Removing covers can expose you to high voltage and other dangerous conditions. Request a qualified service person to perform servicing.
14. Repair — If any of the following conditions occurs, unplug the power cord from the AC outlet, and request a qualified service person to perform repairs.
 - a. When the power cord or plug is damaged.
 - b. When a liquid was spilled on the product or when objects have fallen into the product.
 - c. When the product has been exposed to rain or water.
 - d. When the product does not operate properly as described in the operating instructions.

Do not touch the controls other than those described in the operating instructions. Improper adjustment of controls not described in the instructions can cause damage, which often requires extensive adjustment work by a qualified technician.
 - e. When the product has been dropped or damaged.
 - f. When the product displays an abnormal condition. Any noticeable abnormality in the product indicates that the product needs servicing.
15. Replacement parts — In case the product needs replacement parts, make sure that the service person uses replacement parts specified by the manufacturer, or those with the same characteristics and performance as the original parts. Use of unauthorized parts can result in fire, electric shock and/or other danger.
16. Safety checks — Upon completion of service or repair work, request the service technician to perform safety checks to ensure that the product is in proper operating condition.
17. Wall mounting — When mounting the product on a wall, be sure to install the product according to the method recommended by the manufacturer.
18. Heat sources — Keep the product away from heat sources such as radiators, heaters, stoves and other heat-generating products (including amplifiers).

SAFETY PRECAUTIONS (Continued)

19. Batteries — Incorrect use of batteries may cause the batteries to burst or ignite. A leaky battery may corrode the equipment, dirty your hands or spoil your clothing. In order to avoid these problems, make sure to observe the precautions below:
 - Use the specified batteries only.
 - Install the batteries with due attention to the plus (+) and minus (-) sides of the batteries according to the instructions in the compartment.
 - Do not mix old and new batteries.
 - Do not mix batteries of different types. Voltage specifications of batteries of the same shape may vary.
 - Replace an exhausted battery with a new one promptly.
 - If you will not use the remote control for a long time, remove the batteries.
 - If leaked battery fluid gets on your skin or clothing, rinse immediately and thoroughly. If it gets into your eye, bathe your eye well rather than rubbing and seek medical treatment immediately. Leaked battery fluid that gets into your eye or your clothing may cause a skin irritation or damage your eye.
20. Usage of the monitor must not be accompanied by fatal risks or dangers that, could lead directly to death, personal injury, severe physical damage or other loss, including nuclear reaction control in nuclear facility, medical life support system, and missile launch control in a weapon system.
21. Do not stay in contact with the parts of the product that become hot for long periods of time. Doing so may result in low-temperature burns.
22. Do not modify this product.

WARNING:

This is a Class A product. In a domestic environment this product may cause radio interference in which case the user may be required to take adequate measures.

An apparatus with CLASS I construction shall be connected to a MAIN socket outlet with a protective earthing connection.

To maintain compliance with EMC regulations, use shielded cables to connect to the following terminals: HDMI input terminal, D-sub input terminal, DisplayPort input terminal and RS-232C input terminal.

If a monitor is not positioned in a sufficiently stable location, it can be potentially hazardous due to falling. Many injuries, particularly to children, can be avoided by taking simple precautions such as:

- Using fixing devices like wall mount brackets recommended by the manufacturer.
- Only using furniture that can safely support the monitor.
- Ensuring the monitor is not overhanging the edge of the supporting furniture.
- Not placing the monitor on tall furniture (for example, cupboards or bookcases) without anchoring both the furniture and the monitor to a suitable support.
- Not standing the monitors on cloth or other materials placed between the monitor and supporting furniture.
- Educating children about the dangers of climbing on furniture to reach the monitor or its controls.
- This equipment is not suitable for use in locations where children are likely to be present unsupervised.

Especially for child safety

- Don't allow children to climb on or play with the monitor.
- Don't place the monitor on furniture that can easily be used as steps, such as a chest of drawers.
- Remember that children can become excited while watching a program, especially on a "larger than life" monitor. Care should be taken to place or install the monitor where it cannot be pushed, pulled over, or knocked down.
- Care should be taken to route all cords and cables connected to the monitor so that they cannot be pulled or grabbed by curious children.

TIPS AND SAFETY INSTRUCTIONS

- The TFT color LCD panel used in this monitor is made with the application of high precision technology. However, there may be minute points on the screen where pixels never light or are permanently lit. Also, if the screen is viewed from an acute angle there may be uneven colors or brightness. Please note that these are not malfunctions but common phenomena of LCDs and will not affect the performance of the monitor.
- Do not display a still picture for a long period, as this could cause a residual image.
- Never rub or tap the monitor with hard objects.
- Please understand that SHARP CORPORATION bears no responsibility for errors made during use by the customer or a third party, nor for any other malfunctions or damage to this product arising during use, except where indemnity liability is recognized under law.
- This monitor and its accessories may be upgraded without advance notice.
- Do not use the monitor where there is a lot of dust, where humidity is high, or where the monitor may come into contact with oil or steam. Do not use in an environment where there are corrosive gases (sulfur dioxide, hydrogen sulfide, nitrogen dioxide, chlorine, ammonia, ozone, etc.). As this could lead to fire.
- Ensure that the monitor does not come into contact with water or other fluids. Ensure that no objects such as paper clips or pins enter the monitor as this could lead to fire or electric shock.
- Do not place the monitor on top of unstable objects or in unsafe places. Do not allow the monitor to receive strong shocks or to strongly vibrate. Causing the monitor to fall or topple over may damage it.
- Do not use the monitor near heating equipment or in places where there is likelihood of high temperature, as this may lead to generation of excessive heat and outbreak of fire.
- Do not use the monitor in places where it may be exposed to direct sunlight. Risk of cabinet deformation and failure if the monitor is used in direct sunlight.
- Images cannot be rotated on this monitor. When using in portrait orientation, you will need to prepare appropriately orientated content in advance.
- The AC outlet shall be installed near the equipment and shall be easily accessible.
- Please be sure to constantly remove dust and garbage that has attached to the ventilation opening. If dust collects in the ventilation opening or the inside of the monitor, it may lead to excessive heat, outbreak of fire, or malfunction. Please request a cleaning of the inside of the monitor from an authorized SHARP servicing dealer or service center.
- Do not touch the screen when the monitor power is turned on, it will lead to a malfunction. When this occurs, turn the monitor power off and then on.
- Do not operate the screen with a hard or pointed object such as a fingernail or pencil.
- Depending on the application used, the touch pen may not function.
- If another USB device is connected to the computer to which the touch panel is connected, do not operate the USB device during touch panel input. Input may not take place correctly.
- Do not allow a cable to come near the screen. This may cause the touch panel to malfunction.
- Continuous operating time and warranty. This product is designed for a maximum daily use of 16 hours. Continual use in excess of 16 hours per day is not covered by the warranty.

The Power Cord

- Use only the power cord supplied with the monitor.
- Do not damage the power cord nor place heavy objects on it, stretch it or over bend it. Also, do not add extension cords. Damage to the cord may result in fire or electric shock.
- Do not use the power cord with a power tap. Adding an extension cord may lead to fire as a result of overheating.
- Do not remove or insert the power plug with wet hands. Doing so could result in electric shock.
- Unplug the power cord if it is not used for a long time.
- Do not attempt to repair the power cord if it is broken or malfunctioning. Refer the servicing to the service representative.

Manual Scope

- Microsoft and Windows are either registered trademarks or trademarks of Microsoft Corporation in the United States and/or other countries.
- The terms HDMI and HDMI High-Definition Multimedia Interface, and the HDMI Logo are trademarks or registered trademarks of HDMI Licensing, LLC in the United States and other countries.
- DisplayPort is a registered trademark of Video Electronics Standards Association.
- Adobe, Acrobat, and Acrobat Reader are either registered trademarks or trademarks of Adobe Systems Incorporated in the United States and/or other countries.
- RoomView, Crestron RoomView and Crestron Connected are either trademarks or registered trademarks of Crestron Electronics, Inc. in the United States and/or other countries.
- Intel, Celeron, and Intel Core 2 Duo are trademarks or registered trademarks of Intel Corporation or its subsidiaries in the U.S.A. and other countries.
- AMD, AMD Sempron, AMD Athlon, and combinations thereof are trademarks of Advanced Micro Devices, Inc.
- All other brand and product names are trademarks or registered trademarks of their respective holders.
- Language of OSD menu used in this manual is English by way of example.
- Illustrations in this manual may not exactly represent the actual product or display.
- This manual assumes use in landscape orientation, except where specifically noted.

LED Backlight

- The LED backlight in this product has a limited lifetime.
 - * If the screen gets dark or does not turn on, it may be necessary to replace the LED backlight.
 - * This LED backlight is exclusive to this product and must be replaced by an authorized SHARP servicing dealer or service center. Please contact an authorized SHARP servicing dealer or service center for assistance.

MOUNTING PRECAUTIONS

- This product is for use indoors.
- When using a commercially available stand or mounting bracket, use a stand or mounting bracket that comply with VESA specifications.
- Since the monitor is heavy, consult your dealer before installing, removing or moving the monitor.
- Mounting the monitor on the wall requires special expertise and the work must be performed by an authorized SHARP dealer. You should never attempt to perform any of this work yourself. Our company will bear no responsibility for accidents or injuries caused by improper mounting or mishandling.
- Use the monitor with the surface perpendicular to a level surface. If necessary, the monitor may be tilted up to 20 degrees upward.
- When moving the monitor, be sure to hold it around the periphery. Do not grasp the screen or tray. This may cause product damage, failure, or injury.
- This monitor should be used at an ambient temperature between 41°F (5°C) and 95°F (35°C). Provide enough space around the monitor to prevent heat from accumulating inside.

For the monitor in landscape orientation

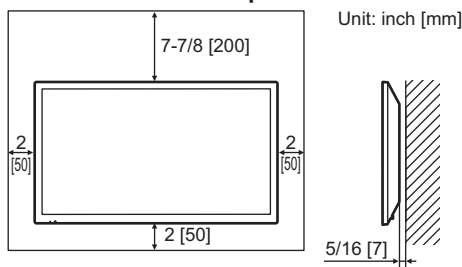

For the monitor in portrait orientation

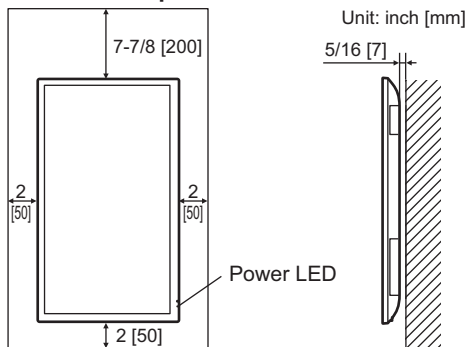

- If it is difficult to provide sufficient space for any reason such as the installation of the monitor inside a housing, or if the ambient temperature may be outside of the range of 41°F (5°C) to 95°F (35°C), install a fan or take other measures to keep the ambient temperature within the required range.
- When installing two or more monitor units side-by-side, provide space of at least 3/16 inch (5 mm) around them to prevent stress on the adjacent unit or structure due to thermal expansion.
- Do not block any ventilation openings. If the temperature inside the monitor rises, this could lead to a malfunction.
- Do not place the monitor on a device which generates heat.

- Adhere to the following when installing the monitor in its portrait orientation. Failing to adhere to the following may cause malfunctions.
 - Install the monitor such that the power LED is located on the bottom side.
 - Set the PORTRAIT/LANDSCAPE INSTALL on the MONITOR menu to PORTRAIT. (See page 28.)
 - Be sure to clamp the power cord (supplied) by using the supplied cable clamp (affixing type). When clamping the power cord, take care not to stress the terminal of the power cord. Do not bend the power cord excessively.

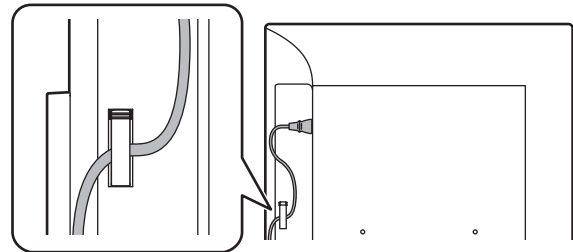

- Use the supplied vertical sticker when you install the monitor in portrait orientation.

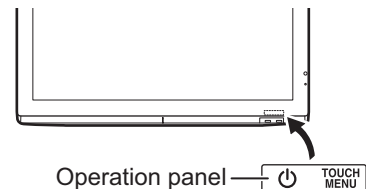

Flat installation

- When using the monitor laying flat on a surface (when the monitor is tilted 20 degrees or more upward from the perpendicular in relation to a level surface), consult an authorized SHARP dealer because there are some specific mounting conditions. Adhere to the following. Failing to adhere to the following may cause malfunctions.
 - Set HORIZONTAL INSTALLATION in the MONITOR menu to UPWARD. (See page 28.)
 - Use the monitor at the ambient temperature within the range of 41°F (5°C) to 86°F (30°C). Provide 7-7/8 inch (200 mm) or more space between the monitor and the floor or other mounting surfaces and surrounding objects to prevent heat from accumulating inside. If it is difficult to provide sufficient space or if the ambient temperature may be outside of the range of 41°F (5°C) to 86°F (30°C), install a fan or take other measures to keep the ambient temperature within the required range.
 - Do not press hard on the LCD panel or otherwise subject it to impacts.

Flat installation (UPWARD)

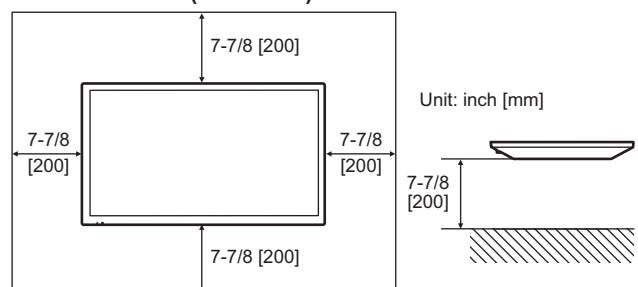

Contents

IMPORTANT INFORMATION	3	Touch action	21
DEAR SHARP CUSTOMER	4	Touch action modes	21
SAFETY PRECAUTIONS	4	Touch action	21
TIPS AND SAFETY INSTRUCTIONS	6	Other functions.....	23
MOUNTING PRECAUTIONS	7	Cautionary points	24
Supplied Components	9	Eraser.....	24
System Requirements	9	Menu Items	25
Part Names	10	Displaying the menu screen.....	25
Connecting Peripheral Equipment	12	Menu item details	26
Connecting the Power Cord	13	Adjustments for computer screen display	30
Binding Cables	14	Controlling the Monitor with a computer (RS-232C) ...	31
Attaching the logo sticker	14	Computer connection	31
Preparing the Remote Control Unit	15	Communication conditions	31
Installing the batteries	15	Communication procedure	31
Remote control operation range.....	15	RS-232C command table.....	33
Mounting a web camera	16	Controlling the Monitor with a computer (LAN).....	36
Turning Power On/Off	17	Settings to connect to a LAN.....	36
Turning on the main power.....	17	Crestron Connected.....	37
Turning power on/off	17	Command-based control.....	38
Basic Operation	18	Troubleshooting	39
		Specifications	41
		Information on the software license for this product ...	46
		Mounting Precautions	
		(For SHARP dealers and service engineers).....	47

For information on the Pen Software, Information Display Downloader or SHARP Display Connect, see the manual for each.

Supplied Components

If any component should be missing, please contact your dealer.

- | | | |
|--|---|---|
| <input type="checkbox"/> Liquid Crystal Display Monitor: 1 | <input type="checkbox"/> Tray: 1 | Stand
<input type="checkbox"/> Stand rod: 2
<input type="checkbox"/> Stand leg: 1
<input type="checkbox"/> VESA angle: 1
<input type="checkbox"/> Stand mounting screw (M3/M4/M6): 4 each |
| <input type="checkbox"/> Remote control unit: 1 | <input type="checkbox"/> Tray mounting screw/
camera mount screw (M3) : 2 each | |
| <input type="checkbox"/> Cable clamp: 3 | <input type="checkbox"/> USB cable: 1 | |
| <input type="checkbox"/> Power cord: 1 | <input type="checkbox"/> Camera mount: 1 | |
| <input type="checkbox"/> Remote control unit battery
(R-03 ("AAA" size)): 2 | <input type="checkbox"/> Camera screw (inch thread): 1 | |
| <input type="checkbox"/> CD-ROM (Utility Disk): 1 | <input type="checkbox"/> Logo sticker: 1 | |
| <input type="checkbox"/> SHARP Display Connect License: 1 | <input type="checkbox"/> Vertical sticker (Operation panel): 1 | |
| <input type="checkbox"/> Setup Manual: 1 | | |
| <input type="checkbox"/> Touch pen: 1 | | |

* SHARP Corporation holds authorship rights to the Utility Disk program. Do not reproduce it without permission.

* For environmental protection!

Do not dispose of batteries in household waste. Follow the disposal instructions for your area.

System Requirements

Computer	PC/AT compatible computer with a USB 2.0 port and able to output a resolution of 1920 x 1080
OS	Windows 7 (32-bit or 64-bit version), Windows 8.1 (32-bit or 64-bit version), Windows 10 (32-bit or 64-bit version) * The touch panel operates with the standard Window driver.
CPU	Intel Celeron or AMD Sempron 1.6 GHz or faster Intel Core 2 Duo or AMD Athlon II X2 2.8 GHz or faster recommended
Memory	At least 2 GB
Free space on hard drive	At least 200 MB (free space separately required for data storage)

To use the touch panel, connect the USB cable (supplied) to your computer.

Pen Software can be installed from the supplied CD-ROM.

When the Information Display Downloader is installed, you can check and download the most recent versions of the software programs.

To install and use the software, see the manual for each.

Download the setup program for the SHARP Display Connect and Touch Viewer with the Information Display Downloader.

Part Names

■ Front view

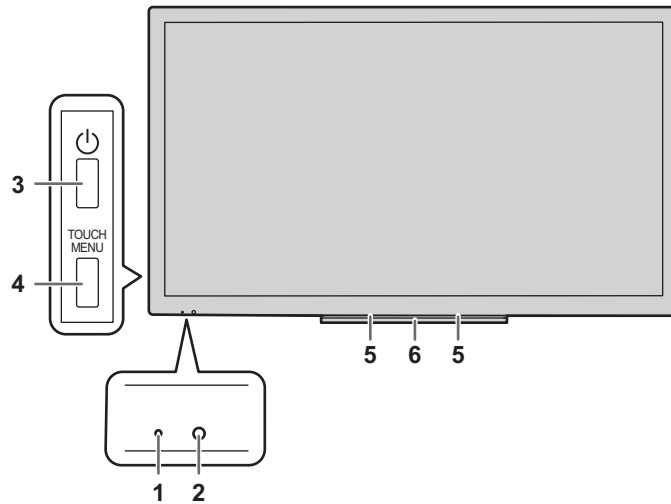

- 1. **Power LED** (See page 17.)
- 2. **Remote control sensor** (See page 15.)
- 3. **POWER button** (See page 17.)
- 4. **TOUCH MENU button** (See page 18.)
- 5. **Speakers**
- 6. **Tray** (See page 47.)

■ Rear view

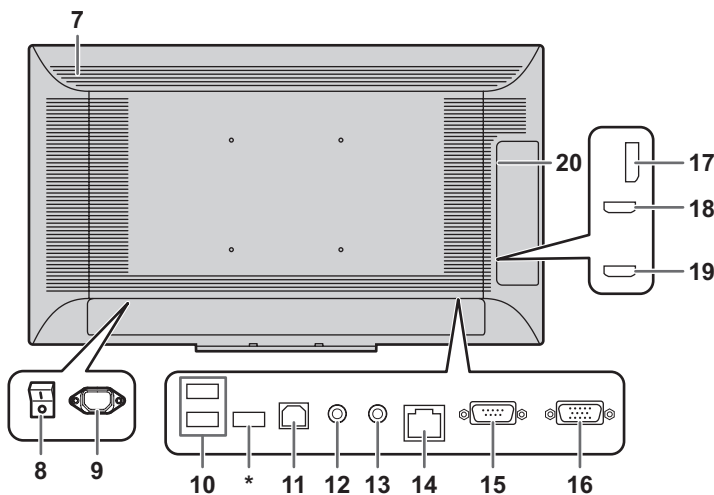

- 7. **Vents**
- 8. **Main power switch** (See page 17.)
- 9. **AC input terminal** (See page 13.)
- 10. **USB port** (See page 13.)
- 11. **USB port (for touch panel)** (See page 13.)
- 12. **Audio output terminal** (See page 12.)
- 13. **Audio input terminal** (See page 12.)
- 14. **LAN terminal** (See page 12.)
- 15. **RS-232C input terminal** (See page 12.)
- 16. **D-sub input terminal** (See page 12.)
- 17. **DisplayPort input terminal** (See page 12.)
- 18. **HDMI1 input terminal** (See page 12.)
- 19. **HDMI2 input terminal** (See page 12.)
- 20. **Expansion slot**
This section is used to connect optional hardware for function expansion. (Offering this attachment location is not a guarantee that future compatible hardware attachments will be released.)

! Caution

- Consult your SHARP dealer for attachment/detachment of optional parts.

* Terminal for firmware updating
Normally not used.

■Remote control unit

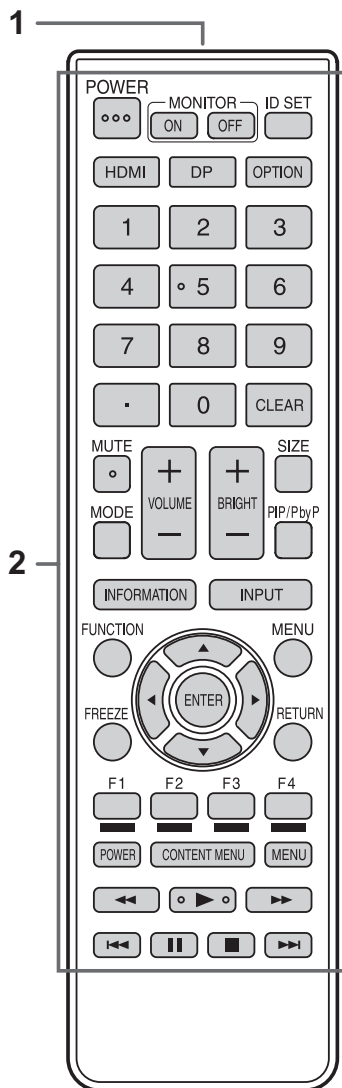

1. Signal transmitter
2. Operation buttons (See pages 18 and 19.)

Connecting Peripheral Equipment

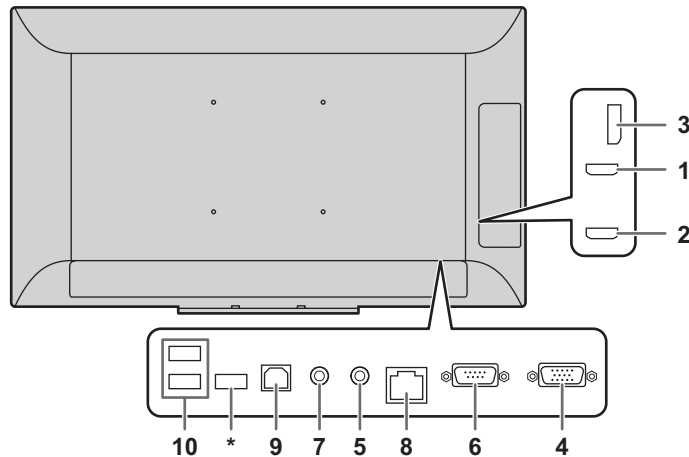

! Caution

- Be sure to turn off the main power switch and disconnect the plug from the power outlet before connecting/ disconnecting cables. Also, read the manual of the equipment to be connected.
- Be careful not to confuse the input terminal with the output terminal when connecting cables. Accidentally reversing cables connected to the input and output terminals may cause malfunctions and the other problems.
- Do not use any cable that has a damaged or deformed terminal. Using such cables may cause malfunctions.

TIPS

- When using the touch panel, connect the USB cable to the computer.
- Images may not be displayed properly depending on the computer (video card) to be connected.
- If the audio output from the playback device is connected directly to speakers or other devices, the video on the monitor may appear delayed from the audio portion. Audio should be played through this monitor by connecting the playback device to the monitor's audio input, and connecting the monitor's audio output to the speakers or other devices.
- The audio input terminals used in each input mode are factory-set as follows.

Input mode	Audio input terminal (Factory setting)
DisplayPort	DisplayPort input terminal
HDMI1	HDMI1 input terminal
HDMI2	HDMI2 input terminal
D-SUB	Audio input terminal
OPTION *	Expansion slot

* When you have used the expansion slot to expand the functions.

1. HDMI1 input terminal

2. HDMI2 input terminal

- Use a commercially available HDMI cable (conforming to the HDMI standard).
- Select the audio input terminal to be used in AUDIO SELECT of the AUDIO menu. When HDMI1 or HDMI2 is selected, connection to the audio input terminal is unnecessary.

3. DisplayPort input terminal

- Use a commercially available DisplayPort cable (conforming to the DisplayPort standard).
- Select the audio input terminal to be used in AUDIO SELECT of the AUDIO menu. When DisplayPort is selected, connection to the audio input terminal is unnecessary.

4. D-sub input terminal

5. Audio input terminal

- Use an audio cable without resistance.

6. RS-232C input terminal

- You can control the monitor from a computer by connecting a commercially available RS-232 straight cable between this terminal and the computer.

7. Audio output terminal

- The output sound varies depending on the input mode.

8. LAN terminal

- You can control the monitor from a computer on a network by connecting a commercially available LAN cable between this terminal and a network.

9. USB port (for touch panel)

- To use the touch panel, connect to your computer with the provided USB cable.

10. USB port

- Can be used as a USB hub (USB 2.0 compliant) of the computer that is connected to the USB port (for touch panel).
- When the monitor power is ON, USB power can be supplied.
When RESUME BY TOUCH is set to ON, USB power can also be supplied in the input signal waiting mode.
- When a function is added using the expansion slot and the input mode is set to OPTION, a USB device can be used with the device in the expansion slot. (When USB PORT SELECTION is set to a setting other than EXTERNAL.)
When this is done, the USB device cannot be used with the computer that is connected to the USB port (for touch panel).

* Terminal for firmware updating
Normally not used.

! Caution

Precautions when a USB storage device (USB flash drive, USB hard disk, etc.) is used

- When USB PORT SELECTION in the SETUP menu is AUTO and the input mode is changed to OPTION, the USB and touch panel connection changes to the expansion slot device.
When the input mode is changed from OPTION, the USB and touch panel connection changes to this monitor.
- Data may be corrupted if the connection is switched while a USB storage device is being accessed.
When connecting a USB storage device, set USB PORT SELECTION to EXTERNAL or OPTION depending on the connected device to fix the connection.
Or, set to MANUAL, change the input mode, and then make sure the USB storage device is not being accessed before switching the connection manually.

Connecting the Power Cord

! Caution

- Use only the power cord supplied with the monitor.
1. Turn off the main power switch.
 2. Plug the power cord (supplied) into the AC input terminal.
 3. Plug the power cord (supplied) into the AC power outlet.

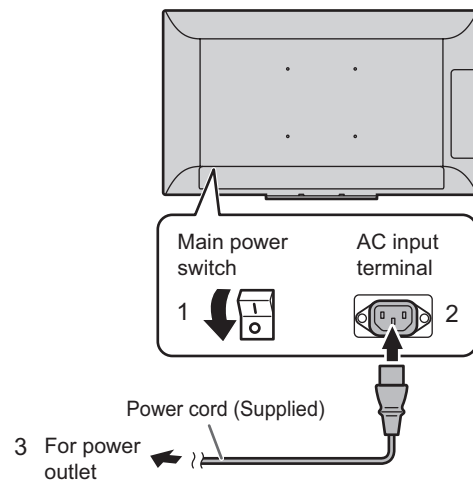

Binding Cables

The cables connected to the terminals on the rear of the monitor can be fastened with the supplied cable clamp.

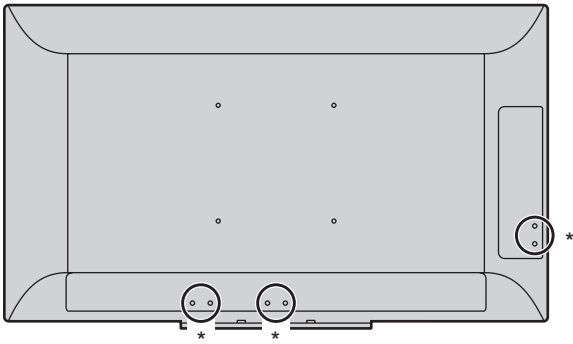

*

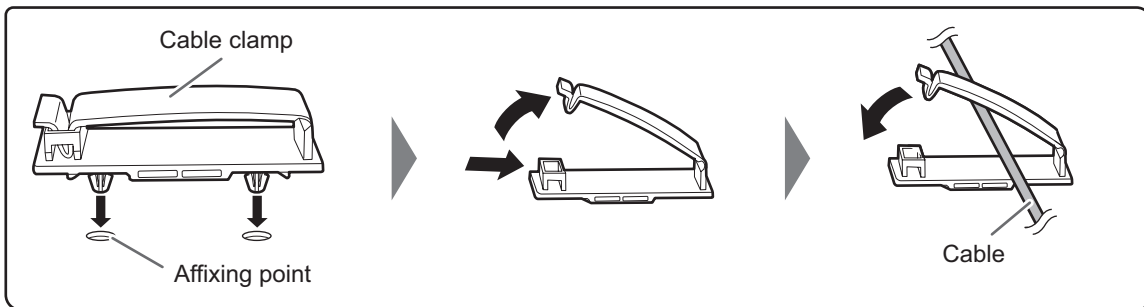

Attaching the logo sticker

You can attach the supplied logo sticker on the monitor.

Landscape orientation

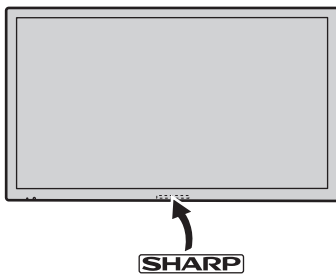

Portrait orientation

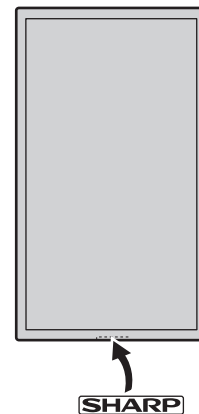

TIPS

- If the tray is not attached, you can see a center mark on the undersurface of monitor.

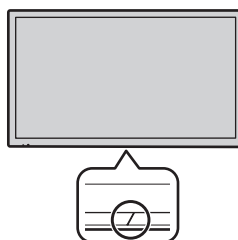

Preparing the Remote Control Unit

Installing the batteries

1. Place your finger on the part marked with the ▲, and then pull the cover off.

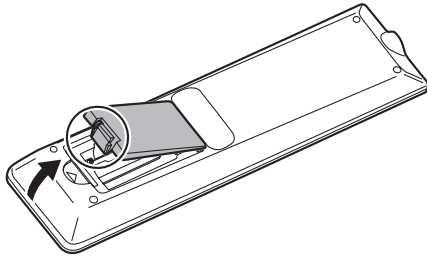

2. See the instructions in the compartment and put in the batteries (R-03 ("AAA" size) x 2) with their plus (+) and minus (-) sides oriented correctly.
3. Close the cover.

TIPS

- When the batteries become exhausted, replace them with new (commercially available) batteries.
- The supplied batteries (R-03 ("AAA" size) x 2) may become exhausted quickly depending on how they are stored.
- If you will not be using the remote control for a long time, remove the batteries.
- Use manganese or alkaline batteries only.

Remote control operation range

The operation range of the remote control unit is approx. 16.4 feet (5 m) at an angle of approx 10° from the center to the top/bottom/right/left of the remote control sensor.

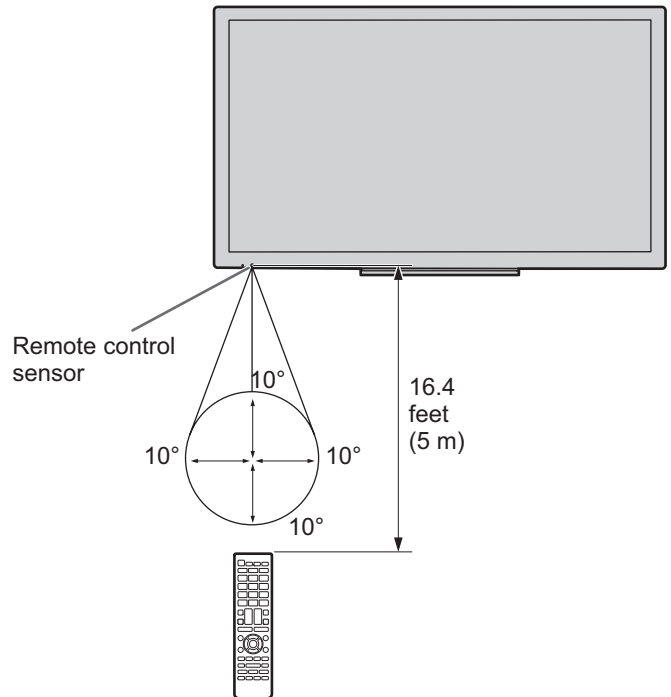

TIPS

- Do not expose the remote control unit to shock by dropping or stepping on it. This could lead to a malfunction.
- Do not expose the remote control unit to liquids, and do not place it in an area with high humidity.
- The remote control unit may not work properly if the remote control sensor is under direct sunlight or strong lighting.
- Objects between the remote control unit and the remote control sensor may prevent proper operation.
- Replace the batteries when they run low as this may shorten the remote control's operation range.
- If a fluorescent light is illuminated near the remote control unit, it may interfere with proper operation.
- Do not use it with the remote control of other equipment such as air conditioner, stereo components, etc.

Mounting a web camera

It is possible to mount a commercially available web camera in the following positions:

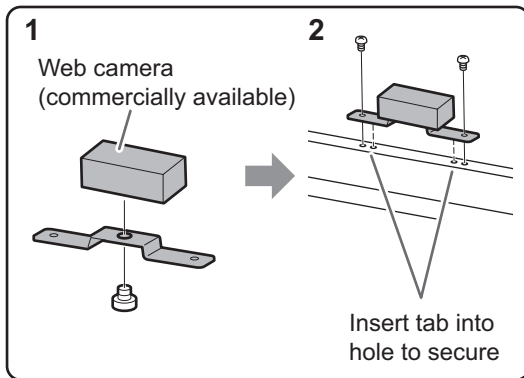

Landscape orientation

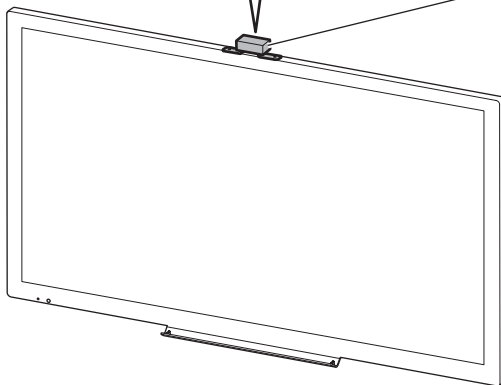

- (1) Attach the web camera (commercially available) to the camera mount with the supplied camera screw (inch thread) (x1).
- (2) Attach the supplied camera mount with the supplied camera mount screw (x2).

Portrait orientation

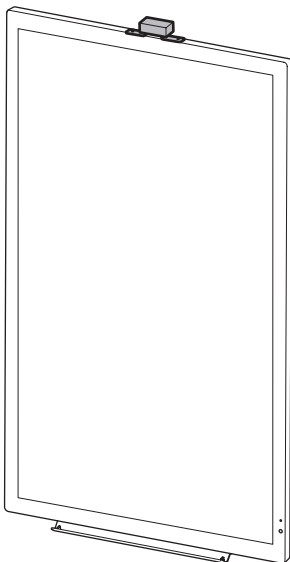

Turning Power On/Off

! Caution

- When all connections are complete, turn on the power.
- Turn on the monitor first before turning on the computer or playback device.
- When switching the main power switch or the POWER button off and back on, always wait for at least 5 seconds. A short interval may result in a malfunction.

Turning on the main power

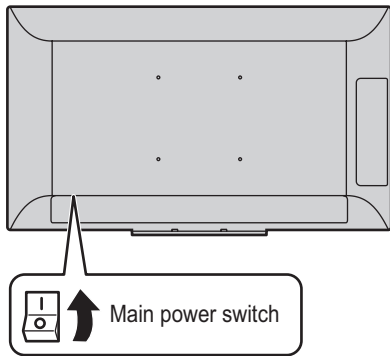

! Caution

- The main power must be turned on/off with the main power switch. Do not connect/disconnect the power cord or turn the breaker on/off while the main power switch is on.
- For a complete electrical disconnection, pull out the main plug.

Turning power on/off

Press the POWER button to turn the power ON/OFF. You can also turn the power ON/OFF by pressing the MONITOR ON button/MONITOR OFF button on the remote control unit.

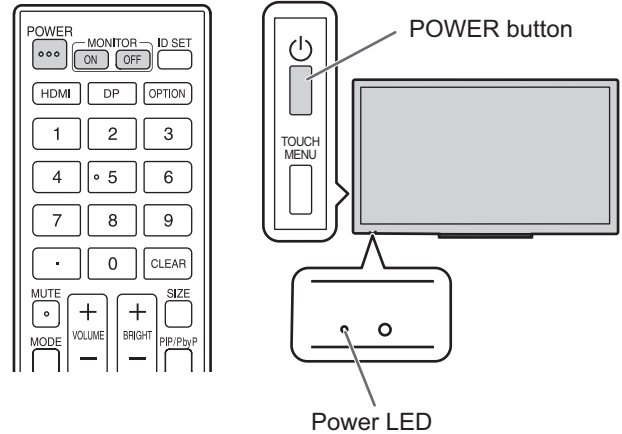

Status	Status of the monitor
Green lit	Power on
Orange lit	Power off (Standby mode)
Green flashing	Input signal waiting mode

TIPS

- When the main power switch is off, the monitor cannot be turned on.
- If the monitor is in the input signal waiting mode and you press the POWER button, the monitor enters standby mode.
- To disable the logo screen from displaying when turning the power ON, set LOGO SCREEN to OFF on the OTHERS menu. (See page 29.)

Basic Operation

Remote control unit

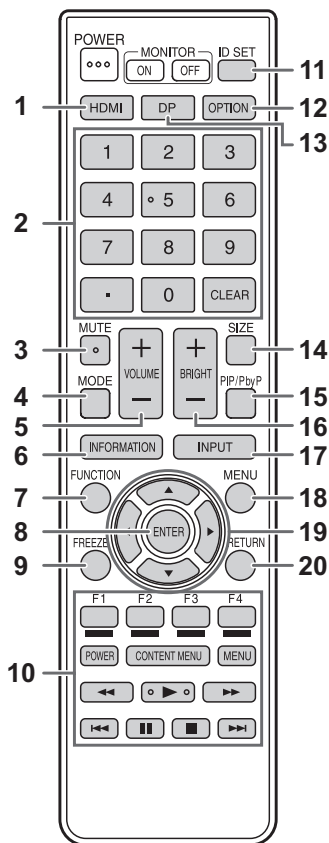

Buttons on the monitor



TOUCH MENU button

Press the TOUCH MENU button to display the touch menu.

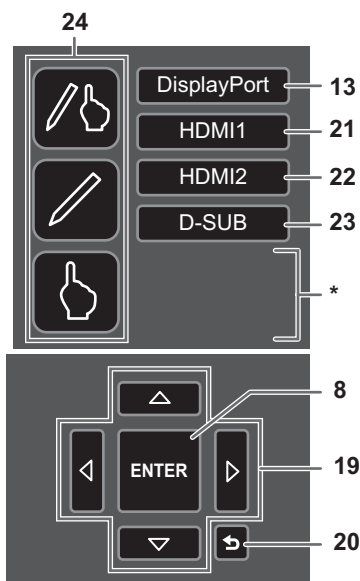

* When a function is added using the expansion slot, a button for changing the input mode will appear.

1. HDMI

Switch the input mode to HDMI1 or HDMI2.

2. Numeric input buttons

These are not used with this monitor.

3. MUTE

Turns off the volume temporarily.

Press the MUTE button again to turn the sound back to the previous level.

4. MODE (Color mode selection)

Each time you press this button, the color mode changes in the following order:

```
STD (PC) → HIGH ILLUMINANCE → AV → USER
→ STD (PC)...
```

- HIGH ILLUMINANCE is a display with colors suited to bright locations.

5. VOLUME +/- (Volume adjustment)

Press + or - to display the volume menu and adjust the volume.

- * If you do not press any buttons for approx. 3 seconds, the VOLUME menu automatically disappears.

6. INFORMATION

Displays monitor information.

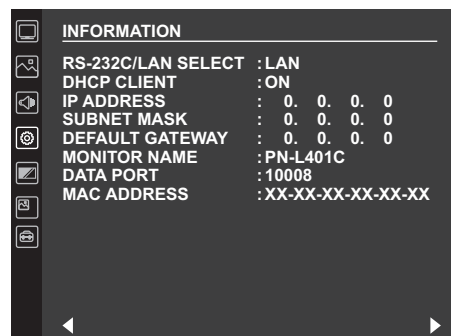
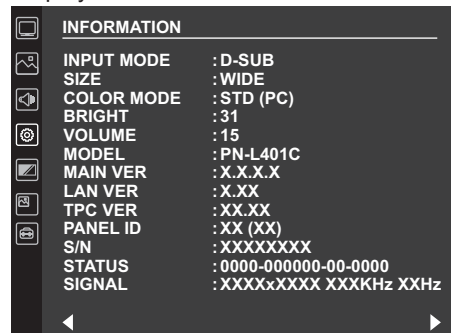

The display changes from INFORMATION1 → INFORMATION2 → INFORMATION3 → clear display, and so on every time you press this button.

Press the MENU button to hide the screen display.

- INFORMATION3 shows the information when you have used the expansion slot to expand the functions.
- The display disappears automatically after approx. 60 seconds.

7. FUNCTION

This is not used with this monitor.

8. ENTER

Confirms the setting.

9. FREEZE

Freezes the video shown on the monitor. To cancel, press any button other than the MUTE button or VOLUME button.

10. Buttons for operating the HDMI-connected device

These are not used with this monitor.

11. ID SET

This is not used with this monitor.

12. OPTION

Switch the input mode to OPTION.

13. DP (DisplayPort)

Switch the input mode to DisplayPort.

14. SIZE (Screen size selection)

The menu is displayed.

Press the ▲ or ▼ buttons to select the screen size. (See page 20.)

15. PIP/PbyP

Each time you press the button, PIP MODES switches in the following order: OFF → PIP → PbyP → OFF.

16. BRIGHT +/- (Brightness adjustment)

Press + or - to display the brightness menu and adjust the brightness.

* If you do not press any buttons for approx. 3 seconds, the BRIGHT menu automatically disappears.

17. INPUT (Input mode selection)

The menu is displayed. Press the ▲ or ▼ buttons to select the input mode, and press ENTER button to enter.

Input mode	Video	Audio
DisplayPort	DisplayPort input terminal	*2
HDMI1	HDMI1 input terminal	
HDMI2	HDMI2 input terminal	
D-SUB	D-sub input terminal	Audio input terminal
OPTION*1	Expansion slot	*2

*1 This is displayed when you have used the expansion slot to expand the functions.

*2 Select the terminal for AUDIO SELECT of the AUDIO menu which is used for audio input. (See page 27.)

18. MENU

Displays and turns off the menu screen. (See page 25.)

19. Cursor

These buttons are used to perform operations such as selecting items, changing adjustment values, and moving the cursor.

20. RETURN

Returns to the previous screen.

21. HDMI1

Switch the input mode to HDMI1.

22. HDMI2

Switch the input mode to HDMI2.



23. D-SUB



Switch the input mode to D-SUB.

24. Touch mode selection



These icons switch the touch action mode. (See page 21.)

■Switching of the USB and touch panel connection

- Switching of the USB and touch panel connection when the input mode is changed to or from OPTION depends on the USB PORT SELECTION setting in the SETUP menu.
- When set to AUTO, the connection changes to the expansion slot device or this monitor.
- When set to EXTERNAL/OPTION, the connection is fixed at this monitor / expansion slot device and does not change.
- When set to MANUAL,  () appears when the input is changed. (Approx. 5 seconds.)



Touch  () to change the connection.

If you are using a USB storage device, make sure it is not being accessed before you switch.

If  () disappears, it will appear when the screen is touched.

■ Switching the screen size

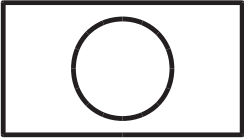
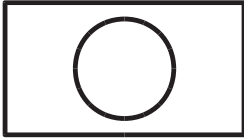
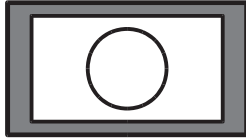
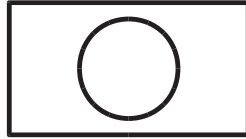
Even when the screen size is changed, the display may remain the same depending on the input signal.

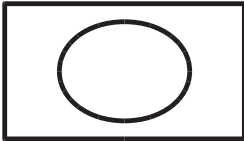
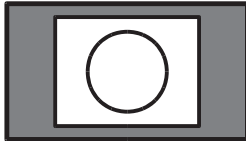
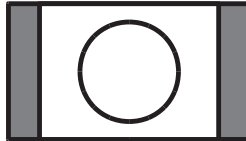
INPUT SIGNAL	WIDE	Dot by Dot	NORMAL
16:9 video  1920×1080, 1280×720 etc.	 Displays image so it fills the entire screen.	 Displays the dots of the input signals as the corresponding dots on the screen.	 Displays image so it fills the entire screen without changing the aspect ratio of the input signal.
Video other than 16:9  640×480, 800×600, 1024×768, 1280×1024 etc.	 Displays image so it fills the entire screen.	 Displays the dots of the input signals as the corresponding dots on the screen.	 Displays image so it fills the entire screen without changing the aspect ratio of the input signal.

TIPS

- Using this monitor's screen-size switching to compress or expand the screen for commercial or public viewing in establishments like cafes or hotels may infringe on the rights of the creators, as protected by Copyright Law, so please be careful.
- The appearance of the original video may change if you select a screen size with a different aspect ratio than the original image (e.g. TV broadcast or video input from external equipment).
- When 4:3 video is viewed with the whole screen using the screen-size switching function of this monitor, the edge of the video may be lost or appear distorted. If you wish to respect the creator's intentions, set the screen size to "NORMAL".
- When playing commercial software, parts of the image (like subtitles) may be cropped. In this case select the optimal screen size using the screen-size switching function of this monitor. With some software, there may be noise or distortion at the edges of the screen. This is due to the characteristics of the software, and is not a malfunction.
- Depending on the original image size, black bands may remain at the edges of the screen.

Touch action

Touch action modes

You can prohibit finger operation or pen operation.



Finger/pen mode

You can use both your finger and a pen. When ERASER FUNCTION is set to OFF, the eraser function (see page 24) cannot be used.



When ERASER FUNCTION is set to ON, the eraser function (see page 24) can be used. (Eraser icon will appear on the finger/pen mode icon.)



Pen-only mode

You can use a pen. You cannot use your finger. The eraser function (see page 24) cannot be used.



Finger-only mode

You can use your finger. A pen cannot be used. The eraser function (see page 24) cannot be used.

1. Press the TOUCH MENU button.

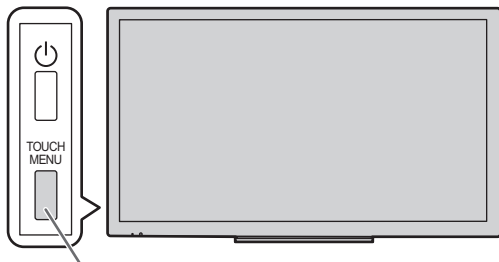

TOUCH MENU button

2. Change the touch mode.

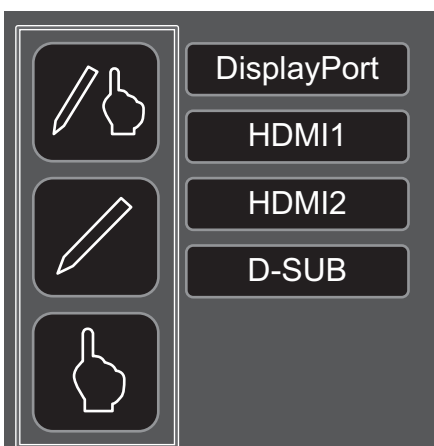

Touch action

Touch actions that can be used with this monitor differ according to operating system and application. The functions of touch actions are also different. For details, check Windows Help and the application's support documentation.

Touch action	OS	
	Windows 8.1 / 10	Windows 7
Single-tap	Yes	Yes
Double-tap	Yes	Yes
Swipe	Yes	Yes
Swipe from edge of screen	Yes	No
Drag-and-drop	Yes	Yes
Flicks	Yes	Yes
Press-and-hold	Yes	Yes
Slide to pan	Yes	Yes
Zoom	Yes	Yes
Press-and-tap	No	Yes
Rotate	Yes	Yes

TIPS

- In Windows 7, if the checkmark has been removed from "Enable multi-touch gestures and inking" in "Pen and touch" in Control Panel, select the checkbox.
- For the procedures for using the touch pen in the Pen Software, see the Pen Software Operation Manual.
- We recommend using with following settings.
When you set items except for the following items, touch action may occasionally deviate.
Input signal : 1920×1080
SIZE : Dot by Dot

Common finger and touch pen actions

Single-tap

Same action as left-clicking a mouse.
Touch with your finger/touch pen.



Touch action

Double-tap

Same action as double-clicking a mouse.
Quickly touch twice with your finger/touch pen.

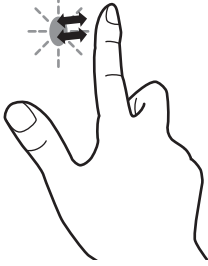

When double-tapping with your finger, be sure to lift your finger sufficiently off the screen after the first tap. If there is insufficient distance between the screen and your finger, double-tap will not take place.

Swipe

Touch the screen with your finger/touch pen, move without lifting, and then stop.

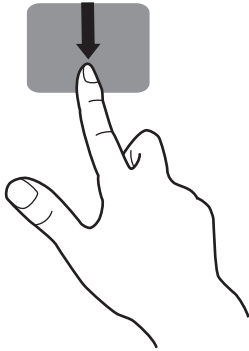

Swipe from edge of screen

After touching the edge of the monitor with your finger/touch pen, move horizontally without releasing your finger/touch pen and then stop.

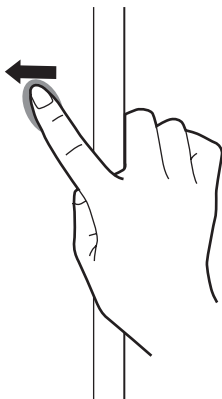

Drag-and-drop

Same action as drag-and-drop with a mouse.
Touch the screen with your finger/touch pen and move without lifting. When you have finished the movement, lift your finger/touch pen.

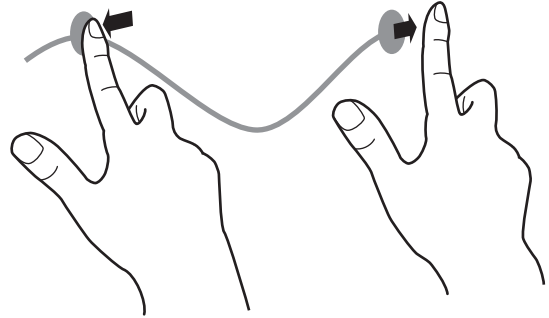

Flicks

Flick your finger/touch pen in the direction of the function you want to use.

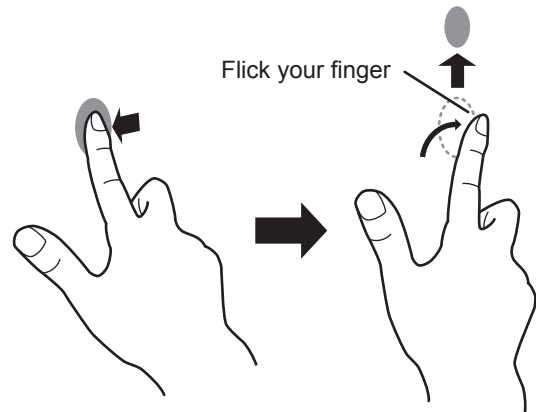

Press-and-hold

Same action as right-clicking a mouse.
Press briefly with your finger/touch pen, and then lift your finger/touch pen from the screen.

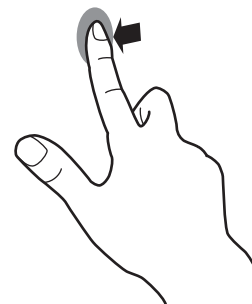

Slide to pan

With your finger/touch pen touching the screen, move it up and down to scroll the screen.

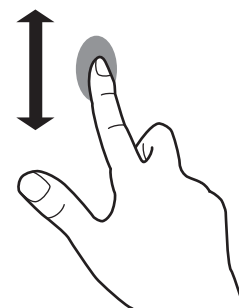

■Finger actions

Zoom

Use in a screen that is capable of enlargement/reduction. Touch the screen with two fingers and move your fingers closer together to reduce the view, or apart to enlarge the view.

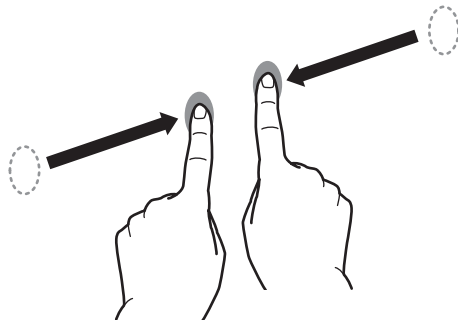

Reduction

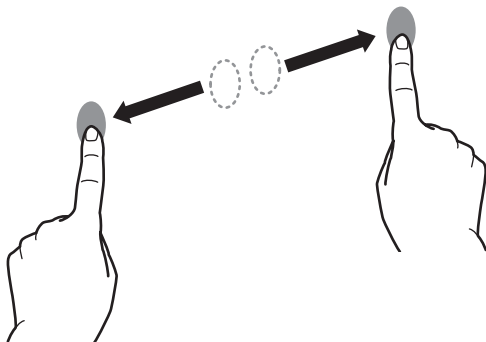

Enlargement

Press-and-tap

Same action as right-clicking a mouse. With one finger touching the screen, tap once (single tap) with another finger.

Tap once (single tap) with another finger

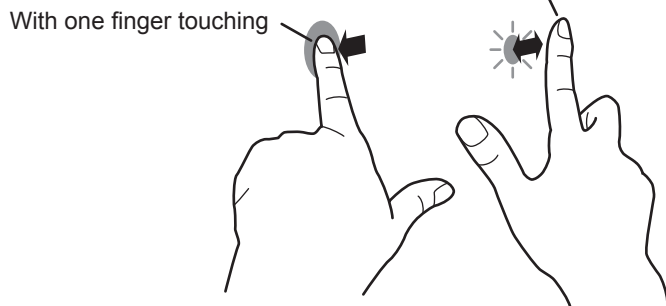

Rotate

Use this action in a screen that is capable of image rotation. Touch the center point of the rotation with one finger. While holding that finger still, move another finger in the desired direction of rotation.

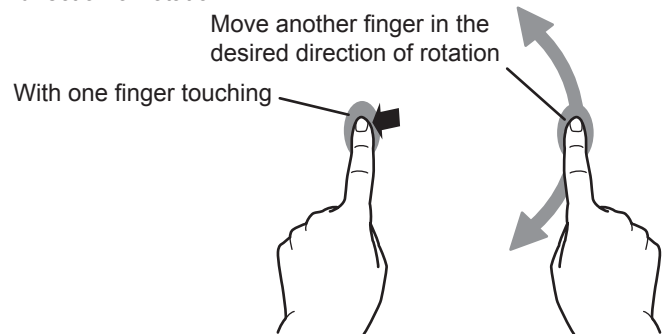

TIPS

- The screen may not respond correctly in the following cases:
 - Touch gesture is too quick
 - The distance between the two points is too short
 - The two points intersect
- Operation with the touch pen is not possible.

Other functions

In Windows 8.1/10, input panel functions can be used. In Windows 7, touch pointer and input panel functions can be used.

For information on these functions, see Windows Help.

Touch pointer :

A translucent image of a mouse appears near the point touched. The left/right buttons of the image can be clicked to perform the same actions as left/right clicking a mouse.

Input panel :

A software keyboard and an input panel with handwriting recognition appear on the screen.

Windows 8.1/10 and Windows 7 (excluding Starter), the ink function of Microsoft Office can be used.

Handwritten comments can be written, and handwriting can be recognized.

For details, see Microsoft Office Help.

Cautionary points

- Note the following when touching by finger:
 - Do not touch with a wet finger.
 - Touch with the ball of your finger.
 - Touch with your bare finger.The screen will not respond if you are wearing a glove.
- Do not use the touch pen for any purpose other than touch panel operation.
- Do not press hard on the pen tip.
- If the pen tip becomes worn or damaged, replace the touch pen. To purchase a new touch pen, consult your dealer.
- This may not operate correctly if there is an inverter fluorescent light nearby.
- If there is dirt or foreign matter on the tip of the touch pen, remove it. Foreign matter may damage the screen.
- The touch pen position may occasionally deviate in the login screen. In this case, use the keyboard or mouse.
- If the USB cable becomes disconnected, the touch panel may not operate correctly after the USB cable is reconnected. In this case, restart the computer.

Eraser

In the Pen Software, you can erase an area of the screen that you touch with your 5 fingers.

1. Set ERASER FUNCTION to ON. (See page 29.)
2. Change to Finger/pen mode. (See page 21.)
3. You can touch the screen with 5 fingers, and when the cursor changes to the eraser, move your fingers.

Also read the Pen Software manual.



Menu Items

Displaying the menu screen

Video and audio adjustment and settings of various functions are enabled. This section describes how to use the menu items. See pages 26 to 29 for details of each menu items.

! Caution

- Do not turn the main power switch off while the menu items are being displayed. Doing so may initialize the settings.

■ Example of operation

(Adjusting CONTRAST in the PICTURE menu)

1. Press the TOUCH MENU or MENU button.

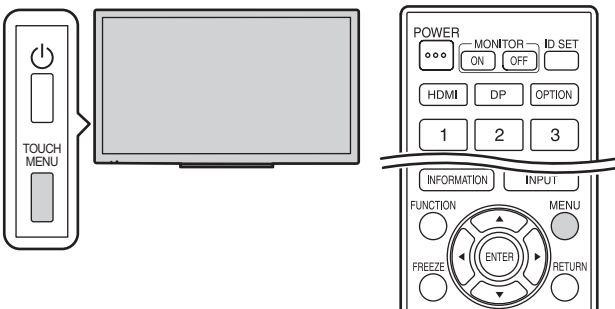

The menu screen appears.

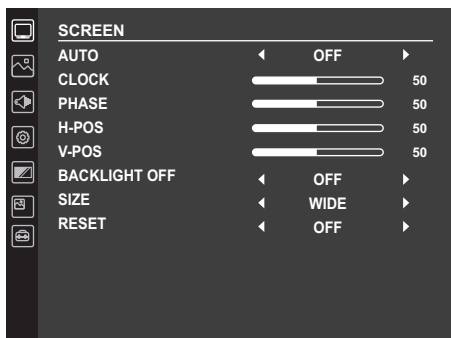

2. Press the ▲ or ▼ button to select PICTURE, and press the ENTER button.

3. Press the ▲ or ▼ button to select CONTRAST.

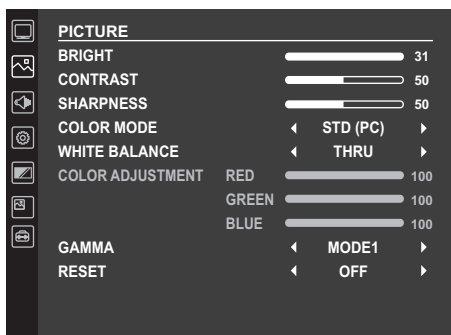

4. Press the ◀ or ▶ button to adjust the setting.

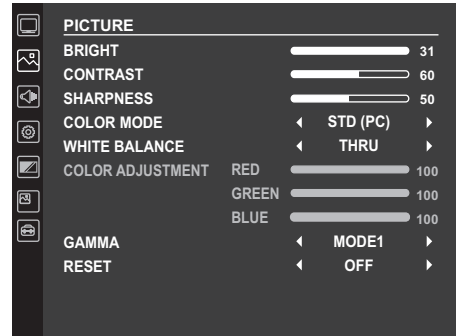

5. Press the TOUCH MENU or MENU button.

The menu screen closes.

TIPS

- The menu will differ depending on the input mode.

Menu Items

Menu item details

The menu will differ depending on the input mode.

■ SCREEN (🖥️)

AUTO (D-SUB)

The CLOCK, PHASE, H-POS, and V-POS are automatically adjusted.

CLOCK (D-SUB)

Adjusts frequency for sampling clock for applicable video.

Adjust when there is flickering in the form of vertical stripes.

When using the adjustment pattern (see page 30), make adjustments so that no vertical stripe noise appears in it.

PHASE (D-SUB)

Adjusts sampling clock phase for applicable video. Useful when small characters appear with low contrast and/or there are flickers at corners. When using the adjustment pattern (see page 30), make adjustments so that no horizontal stripe noise appears in it.

* Adjustments to PHASE should be made only after CLOCK has been correctly set.

H-POS

Adjust the horizontal position of the image.

V-POS

Adjust the vertical position of the image.

BACKLIGHT OFF

When set to ON, the backlight turns off. Audio does not turn off.

SIZE

Selects screen size. (See page 20.)

RESET

Resets the values of the SCREEN menu items to the factory preset values.

Select ON and then press the ENTER button.

■ PICTURE (🖼️)

BRIGHT

Adjusts the backlight brightness. Brightness can also be adjusted using a remote control unit. (See page 19.)

CONTRAST

Adjusts the difference between the bright and dark portions of the image.

SHARPNESS

Adjusts the sharpness of the image.

COLOR MODE

Changes the color mode on the screen. The color mode on the screen can also be changed using a remote control unit. (See page 18.)

WHITE BALANCE

THRU.....Displays the input signal level as is.

USER.....Used for adjusting of each of red component, green component, blue component respectively using COLOR ADJUSTMENT.

6500K/9300K.....The setting values are shown for reference. The color temperature of the screen varies over time. This function is not intended to keep the color temperature constant.

COLOR ADJUSTMENT

Adjust item when the WHITE BALANCE is set to USER. Press the ENTER button to adjust.

REDAdjusts bright-toned red component.

GREEN.....Adjusts bright-toned green component.

BLUEAdjusts bright-toned blue component.

GAMMA

Selects the gamma.

RGB INPUT RANGE (HDMI/DisplayPort/OPTION)

Sets the RGB input signal range.

When using HDMI, DisplayPort or OPTION set to AUTO, the RGB input signal is detected automatically. Use AUTO normally.

If the RGB input signal range cannot be set appropriately even when using AUTO, set according to the image. When the setting is different, images will be displayed with washed out blacks and compressed gradients.

RESET

Resets the values of the PICTURE menu items to the factory preset values.

Select ON and then press ENTER button.

■ AUDIO (🔊)

VOLUME

Adjusts the volume. Volume can also be adjusted using a remote control unit. (See page 18.)

AUDIO OUTPUT

Sets the volume of sound output from the audio output terminal.

VARIABLE1 You can adjust the volume from the speakers of this monitor and the audio output terminal simultaneously by using VOLUME.

VARIABLE2 You can adjust the volume from the audio output terminal by using VOLUME.
Sound will not be output from the speakers of this monitor.

MUTE WITH FREEZE

Set whether or not audio turns off during freeze.

AUDIO SELECT (HDMI/DisplayPort/OPTION)

Selects the terminal used to input audio signals in each input mode.

RESET

Resets the values of the AUDIO menu items to the factory preset values.
Select ON and then press the ENTER button.

■ SETUP (⚙️)

LANGUAGE

Sets the display language for the menu screen.

RS-232C/LAN SELECT

Selects the method with which to control the monitor from the computer.

BAUD RATE

Selects the communication speed used for RS-232C communication.

LAN SETUP

Configures the settings to control the monitor from the computer via LAN. (See page 36.)

Crestron Connected

Select this when using a Crestron device. When this function is set to ON, the monitor can be controlled via network using equipment and application software of Crestron Electronics, Inc.

This monitor supports application software RoomView from Crestron Electronics, Inc.

This is a function to connect a system developed by Crestron Electronics, Inc. which manages and controls multiple system devices connected to the network.

For details of Crestron Connected, refer to the Crestron Electronics, Inc. website. (Provided only In English.)
<http://www.crestron.com/>

For the download of RoomView Express, refer to the Crestron Electronics, Inc. website. (Provided only In English.)
<http://www.crestron.com/getroomview>

USB PORT SELECTION



Specify the setting for the USB and touch panel connection when the input mode is changed to or from OPTION.



AUTOThe connection automatically changes when the input mode changes.

EXTERNALThe USB and touch panel connection is fixed at this monitor.
The touch panel and USB device cannot be used with the expansion slot device.

OPTIONThe USB and touch panel connection is fixed at the expansion slot device.
The touch panel and USB device cannot be used with this monitor.

MANUALWhen the input is changed,  () appears. (Approx. 5 seconds.)

Touch  () to change the connection.

If  () disappears, it will appear when the screen is touched.

INFORMATION

Displays monitor information. (See page 18.)

ALL RESET

Resets all the settings to the factory default settings. If the video is distorted after this is executed, turn off the power with the POWER button on the monitor, and then disconnect and reconnect the power cord.

Menu Items

■ MONITOR ()

■ PORTRAIT/LANDSCAPE INSTALL

LANDSCAPELandscape orientation

PORTRAITPortrait orientation

■ HORIZONTAL INSTALLATION

OFFPortrait/landscape installation

UPWARDThe display screen faces up.

■ OSD H-POSITION

Adjusts the horizontal display position of menu screen.

■ OSD V-POSITION

Adjusts the vertical display position of menu screen.

■ POWER SAVE MODE

When OFF is selected, startup time from standby mode is reduced. Note, however that, more power will be consumed in standby mode.

When ON is selected, current consumption is reduced while the monitor is in standby mode. Note, however, that the startup time from standby mode becomes longer.

■ OFF IF NO OPERATION

Determines whether or not to set the monitor to go into standby mode when there is no operation from the remote control unit, RS-232C commands, or LAN for over 4 hours.

■ PIP ()

■ PIP MODES

Sets the display method.

OFFDisplays one screen.

PIPDisplays a sub screen inside a main screen.

PbyPDisplays a main screen and a sub screen in a line.

■ PIP SIZE

Sets the size of the sub screen in PIP mode.

■ PIP POS

Adjusts the position of the sub screen in PIP mode.

■ PIP SOURCE

Selects the input signal of the sub screen in PIP or PbyP mode.

■ SOUND CHANGE

Sets the sound which is output in PIP or PbyP mode.

■ RESET

Resets the values of the PIP menu items to the factory preset values.

Select ON and then press the ENTER button.

■ OTHERS (📁)

POWER MANAGEMENT

POWER MANAGEMENT determines whether or not to switch modes from no signal to the input signal waiting mode.

NO SIGNAL AUTO INPUT SEL.

Specify whether to change inputs automatically. When ON is selected and no signal is present in the selected input mode, the monitor automatically changes the selected mode to another mode where a video signal is present.

LOGO SCREEN

Sets whether or not to display the logo screen.

ERASER FUNCTION

Set whether or not the eraser function (see page 24) is used.

RESUME BY TOUCH

Set whether or not the screen is restored when touched in the input signal waiting mode.

OFF Turn off screen restoration.

ON Turn on screen restoration. Note that this will increase power consumption in the input signal waiting mode.

OPTION

Set whether or not the expansion slot is used.

MONITOR LOCK

You can disable operations on the monitor and the remote control unit that use buttons.

OFF Enables operation.

REMOTE CONTROL Prohibits remote control operation.

MONITOR BUTTONS Prohibits monitor button operation.

BOTH Prohibits remote control and monitor button operation.

To release the operation lock, perform the steps below.

1. Press the SIZE button until "F" appears in the upper left corner of the screen.
2. While "F" is displayed, press the ▲, ▼, ◀, ▶ buttons in that order.

■Dual screen display

You can display two screens simultaneously.
Set this function with PIP MODES in the PIP menu.

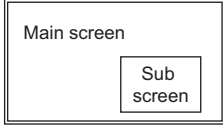
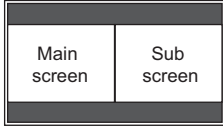
PIP		A sub screen is displayed inside a main screen.
PbyP		A main screen and a sub screen are displayed in a line.

* The currently selected input signal is displayed on the main screen.

TIPS

- You might infringe on a copyright of the author which is protected by copyright law when you display the images of the computer screen and television/VCR simultaneously for profit-making or to show the image to the public.
- The screen size for dual-screen display is the same as the screen size for single-screen display. The Dot by Dot screen is displayed in NORMAL size except when it is set as the PIP main screen.
- When dual-screen display is selected, the NO SIGNAL AUTO INPUT SEL. function is disabled.
- When dual-screen display is selected, the AUDIO menu cannot be set.
- When an interlaced signal (1080i, 480i, video) is input to the sub screen, horizontal lines may flicker. If this happens, display the image on the main screen.
- Touch operation cannot be used in the sub screen.
- When you set PbyP, touch action deviate.

Adjustments for computer screen display

■Automatic adjustment

When you use D-SUB to display a computer screen for the first time, or when you change the setting of the computer, use the automatic screen adjustment.

1. Switch the input to D-SUB and display the adjustment pattern. (See the description below.)
2. Press the TOUCH MENU or MENU button.
3. Press the ▲ or ▼ button to select SCREEN, and press the ENTER button.
4. Press the ▲ or ▼ button to select AUTO.
5. Press the ◀ or ▶ button to select ON, and press the ENTER button.

The automatic adjustment is complete in several seconds.

TIPS

- If the screen cannot be adjusted properly with one automatic adjustment, repeat the automatic adjustment two or three times. Try manual adjustment if necessary.

■Screen display for adjustment

Before adjusting the image quality or picture, display an image to brighten the entire screen. If you are using a Windows computer, use the adjustment pattern on the supplied CD-ROM.

Opening the adjustment pattern

The following example is performed in Windows 7.

1. Load the supplied CD-ROM into the computer's CD-ROM drive.
2. Open [CD Drive] in [Computer].
3. Double-click [Adj_uty.exe] in the [Monitor] folder.
The adjustment pattern will appear.

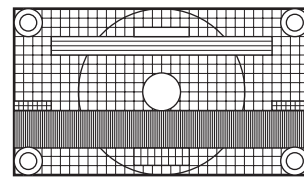

4. When adjustment is finished, press the [Esc] on the computer's keyboard to quit the adjustment program.
5. Eject the CD-ROM from the CD-ROM drive.

TIPS

- If the display mode on the computer you are using is 65000 colors, the color levels in the color pattern may appear differently or grayscale may appear to be colored. (This is due to the specifications of the input signal and is not a malfunction.)

Controlling the Monitor with a computer (RS-232C)

You can control this monitor from a computer via RS-232C (COM port) on the computer.

TIPS

- To control the monitor via RS-232C, set RS-232C/LAN SELECT to RS-232C.
- You cannot use RS-232C and LAN control simultaneously.

Computer connection

Connect with RS-232 straight cable between the computer's COM port (RS-232C connector) and the RS-232C input terminal on the monitor.

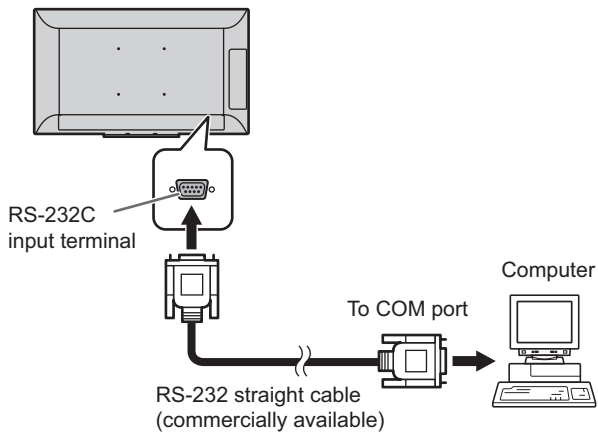

Communication conditions

Set the RS-232C communication settings on the computer to match the monitor's communication settings as follows:

Baud rate	*
Data length	8 bits
Parity bit	None

Stop bit	1 bit
Flow control	None

* Set to the same baud rate as the BAUD RATE setting of SETUP menu. (Initial setting: 38400 bps)

Communication procedure

■ Command format

When a command is sent from the computer to the monitor, the monitor operates according to the received command and sends a response message to the computer.

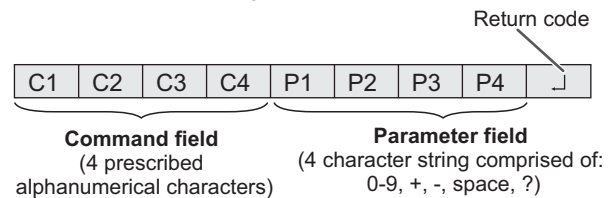

Example: VOLM0030
VOLM 30

- * Be sure to input 4 characters for the parameter. Pad with spaces (" ") if necessary. ("␣" is a return code (0DH, 0AH or 0DH))
Wrong : VOLM30␣
Right : VOLM 30␣

When the parameter part is 5 or more characters, specify parameters using a specified number of characters without using spaces.

Example: TCPP01025

If a command has "R" listed for "DIRECTION" in the "RS-232C command table" on page 33, the current value can be returned by using "?" as the parameter.

Example:

VOLM ? ? ? ?	←	From computer to monitor (How much is current volume setting?).
30	←	From monitor to computer (Current volume setting: 30).

Controlling the Monitor with a computer (RS-232C)

■Response code format

When a command has been executed correctly

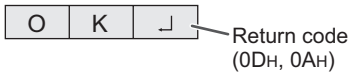

A response is returned after a command is executed.

When a command has not been executed



TIPS

- “ERR” is returned when there is no relevant command or when the command cannot be used in the current state of the monitor.
- If communication has not been established for reasons such as a bad connection between the computer and monitor, nothing is returned (not even ERR).
- “ERR” may be returned when a command cannot be received correctly due to interference from the surrounding environment.

Please ensure that the system or software retries the command if this occurs.

If execution of the command is taking some time



There is command “WAIT” is returned as a returned value. In this case, a value will be returned if you wait a while. Do not send any command during this period.

When RS-232C/LAN SELECT is set to LAN

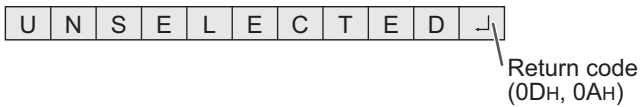

■Communication interval

- After OK or ERR is returned, you must send the following commands.
To set a timeout for the command response, specify 10 seconds or longer.
- Provide an interval of 100 ms or more between the command response and the transmission of the next command.

VOLM0020
OK

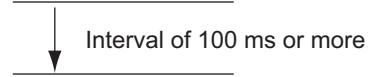

INPS0001
WAIT
OK

TIPS

- When executing ALL RESET, set the timeout period to 30 seconds or longer.

RS-232C command table

How to read the command table

- Command: Command field (See page 31.)
- Direction: W When the "Parameter" is set in the parameter field (see page 31), the command functions as described under "Control/Response Contents".
 R The returned value indicated under "Reply" can be obtained by setting "???" or "???" in the parameter field (see page 31).
- Parameter: Parameter field (See page 31.)
- Reply: Response (Returned value)

Power control/Input mode selection

Function	Command	Direction	Parameter	Reply	Control/Response contents
POWER CONTROL	POWR	W	0		Switches to standby mode.
			1		Enters the power ON state.
		R		0	Standby mode
				1	Normal mode
				2	Input signal waiting mode
INPUT MODE SELECTION	INPS	W	0		Toggle change for input mode. Terminals not selected in INPUT SELECT cannot be selected.
			2		D-SUB
			10		HDMI1
			13		HDMI2
			14		DisplayPort
			21		OPTION
		R		2	D-SUB
				10	HDMI1
				13	HDMI2
				14	DisplayPort
				21	OPTION

SCREEN menu

Function	Command	Direction	Parameter	Reply	Control/Response contents
SIZE	WIDE	WR	1	1	WIDE
			3	3	Dot by dot
			6	6	NORMAL

PICTURE menu

Function	Command	Direction	Parameter	Reply	Control/Response contents
BRIGHT	VLMP	WR	0-31	0-31	
COLOR MODE	BMOD	WR	0	0	STD (PC)
			4	4	HIGH ILLUMINANCE
			9	9	AV
			10	10	USER

Controlling the Monitor with a computer (RS-232C)

AUDIO menu

Function	Command	Direction	Parameter	Reply	Control/Response contents
VOLUME	VOLM	WR	0-31	0-31	

SETUP menu

Function	Command	Direction	Parameter	Reply	Control/Response contents	
RS-232C/LAN SELECT	CTLS	WR	0-1	0-1	0: RS-232C 1: LAN	
LAN SETUP	DHCP CLIENT	DHCP	0-1	0-1	0: OFF, 1: ON * Apply the settings to this monitor by NTUP.	
	IP ADDRESS	IPAD	XXXXXXXXXX	XXXXXXXXXX	X: Only number is ok. If the number is less than 3 digits, to three digits to fill zero. Example: 192168150001 * Apply the settings to this monitor by NTUP.	
	SUBNET MASK	SBMK	XXXXXXXXXX	XXXXXXXXXX	X: Only number is ok. If the number is less than 3 digits, to three digits to fill zero. Example: 255255255000 * Apply the settings to this monitor by NTUP.	
	DEFAULT GATEWAY	DFGW	XXXXXXXXXX	XXXXXXXXXX	X: Only number is ok. If the number is less than 3 digits, to three digits to fill zero. Example: 000000000000 * Apply the settings to this monitor by NTUP.	
	User name	USER	WR	XXXXXXXX	XXXXXXXX	Set the username for connection to this monitor by LAN. X: 8 characters or less; half-width alphanumeric characters, "-", and "_". (The field can be left blank, but spaces cannot be entered.)
	Password	PASS	WR	XXXXXXXX	XXXXXXXX	Set the password for connection to this monitor by LAN. X: 8 characters or less; half-width alphanumeric characters, "-", and "_". (The field can be left blank, but spaces cannot be entered.)
	Monitor name	MNTR	WR	XXXXXXXX XXXXXXXX	XXXXXXXX XXXXXXXX	X: 16 characters or less; half-width alphanumeric characters, "-", and "_". (The field can be left blank, but spaces cannot be entered.)
	Auto logout time	LOTM	WR	0000-65535	0000-65535	Set the time that display terminate a network connection automatically by minutes.
	Data port	TCPD	WR	01025-65535	01025-65535	Set the TCP port number for data communication. * Apply the settings to this monitor by NTUP.
Reflecting LAN setting	NTUP	W	1	1	Applies the DHCP CLIENT, IP ADDRESS, SUBNET MASK, DEFAULT GATEWAY, and Data port settings to this monitor.	
Crestron Connected	CRCN	WR	0-1	0-1	0: OFF, 1: ON	
ALL RESET	RSET	W	1		1: ALL RESET	

MONITOR menu

Function	Command	Direction	Parameter	Reply	Control/Response contents
PORTRAIT/LANDSCAPE INSTALL	STDR	WR	0-1	0-1	0: LANDSCAPE, 1: PORTRAIT
HORIZONTAL INSTALLATION	MLAY	WR	0-1	0-1	0: OFF, 1: UPWARD

PIP menu

Function	Command	Direction	Parameter	Reply	Control/Response contents
PIP MODES	MWIN	WR	0-2	0-2	0: OFF, 1: PIP, 2: PbyP
PIP SIZE	MPSZ	WR	0-2	0-2	0: SMALL, 1: MEDIUM, 2: LARGE
PIP POS	MWPS	WR	0-3	0-3	0: UPPER RIGHT, 1: UPPER LEFT, 2: LOWER RIGHT, 3: LOWER LEFT
PIP SOURCE	MWIP	WR	2	2	D-SUB
			10	10	HDMI1
			13	13	HDMI2
			14	14	DisplayPort
			21	21	OPTION
SOUND CHANGE	MWAD	WR	1-2	1-2	1: MAIN, 2: SUB
RESET	RPIP	W	1		

OTHERS menu

Function	Command	Direction	Parameter	Reply	Control/Response contents
MONITOR LOCK	ALTG	WR	0-3	0-3	0: REMOTE CONTROL, 1: MONITOR BUTTONS, 2: BOTH, 3: OFF

Controlling the Monitor with a computer (RS-232C)

Others

Function		Command	Direction	Parameter	Reply	Control/Response contents
RESOLUTION CHECK		PXCK	R		-	Returns current resolution in the form of hhh, vvv.
MUTE		MUTE	WR	0-1	0-1	0: OFF, 1: ON
INFORMATION	MODEL	INF1	R		Value	
	SERIAL NO	SRNO	R		Value	
TEMPERATURE SENSOR		DSTA	R		0	Internal temperature normal
					1	Internal temperature abnormal has occurred and the monitor is in standby mode
					2	Internal temperature abnormal occurred (To delete the information of temperature abnormal, turn off the main power.)
					3	Internal temperature abnormal has occurred and backlight brightness is dimmed
					4	Temperature sensor abnormal
TEMPERATURE ACQUISITION		ERRT	R		Value	Returns the temperature at the temperature sensors. Indicates a temperature sensor abnormality when "126" is returned.
CAUSE OF LAST STANDBY MODE		STCA	W	0		Initialization
					0	No detectable error has occurred
					1	Standby mode by POWER button
					2	Main power off by the main power switch
					3	Standby mode by RS-232C or LAN
					4	Input signal waiting mode by No Signal
					6	Standby mode by abnormal temperature
					20	Standby mode by OFF IF NO OPERATION setting

Controlling the Monitor with a computer (LAN)

Your monitor can be connected to a LAN allowing you to control it from a computer on the LAN. The connection requires a commercially available LAN cable (UTP cable, Category 5, straight through).

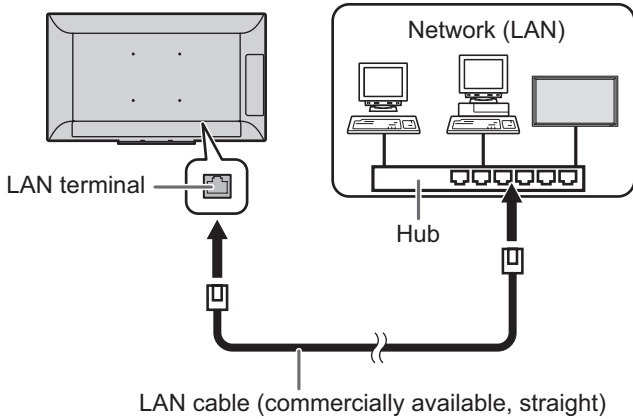

TIPS

- You must assign an IP address to the monitor by following the procedures in "Settings to connect to a LAN". (See the description on the right.)
- When POWER SAVE MODE is set to ON, control is not possible in standby mode.
- To control the monitor via LAN, set RS-232C/LAN SELECT to LAN. (See page 27.)
- You cannot use RS-232C and LAN control simultaneously.

Settings to connect to a LAN

Set the monitor's IP address and subnet mask to match the settings of your LAN.

The settings depend on the configuration of your LAN. Ask your LAN administrator for details.

Set RS-232C/LAN SELECT on the SETUP menu to LAN, and then set the LAN SETUP options. (See page 27.)

After setting each item, select SET in SET/RESET and press the ENTER button.

DHCP CLIENT

If your LAN has a DHCP server and you wish to obtain an address automatically, change this setting to ON.

To set the address manually, set this to OFF.

IP ADDRESS

If the DHCP CLIENT is set to OFF, specify an IP address. Press the ◀ or ▶ button to select items, and press the ▲ or ▼ button to change the values.

SUBNET MASK

If the DHCP CLIENT is set to OFF, specify the subnet mask. Press the ◀ or ▶ button to select items, and press the ▲ or ▼ button to change the values.

DEFAULT GATEWAY

If the DHCP CLIENT is set to OFF, specify the default gateway.

If you are not using a default gateway, specify "0.0.0.0". Press the ◀ or ▶ button to select items, and press the ▲ or ▼ button to change the values.

SET/RESET

SET.....Applies the LAN settings to the monitor.

RESET.....Resets the LAN settings to the factory preset values.

Crestron Connected

You use the web browser on a computer on the LAN to control the monitor.

Access the monitor using the web browser.

1. Launch the web browser on the computer.
2. In the "Address" box, type "http://" followed by your monitor's IP address followed by "/", then press the Enter key.

You can confirm the IP address with the INFORMATION function.

Display the Crestron Connected control menu.

Control Menu



1. Operate below functions.
 - Power..... Turn the power ON/OFF.
 - Mute..... Turns off the volume temporarily.
 - Vol-/Vol+ Adjust the volume of the sound.
2. Change the input mode.
3. Operate below functions.
 - Contrast Adjusts the contrast.
 - Sharpness..... Adjusts the sharpness.
4. Operates the menu screen for the monitor.
5. Switches the pages to tools, information and help tab.

Tools

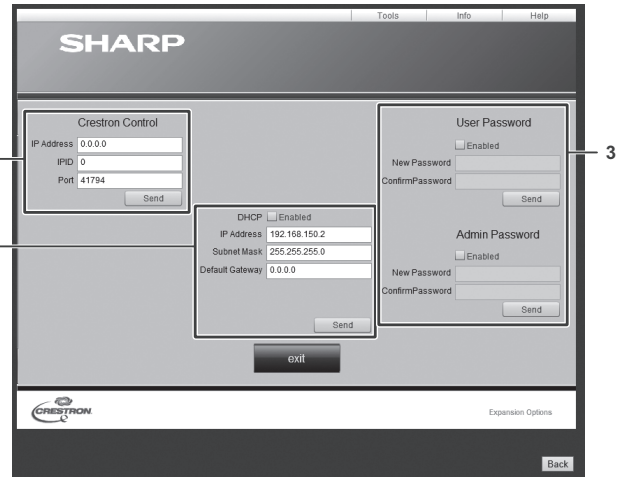

1. Setting for Crestron Control.
2. Setting for monitor network.
 - DHCP
 - IP Address
 - Subnet Mask
 - Default Gateway
3. Security Setting. Sets the password for the user and administrators rights on Control Menu.

Info

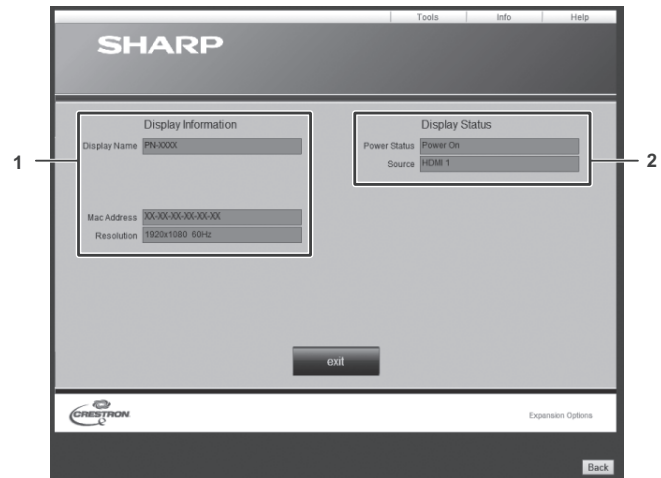

1. Display below information.
 - Display Name
 - Mac Address
 - Resolution
2. Display below status.
 - Power Status
 - Input

Help



Sends or receives messages to the administrators who uses "Crestron Connected".

Command-based control

You can control the monitor using RS-232C commands (see page 31) via terminal software and other appropriate applications.

Read the manual for the terminal software for detailed instructions.

(1) Connect the computer to the monitor.

1. Specify the IP address and data port number (10008) and connect the computer to the monitor.

When connection has been established successfully, [Login:] is returned as response.

2. Send the user name.
 - Send [User name] + [Enter].
 - If the user name is not set, send [Enter].
 - When the transmission is successful, [Password:] is returned as response.
3. Send the password.
 - Send [Password] + [Enter].
 - If the password is not set, send [Enter].
 - When the transmission is successful, [OK Enter] is returned as response.

(2) Send commands to control the monitor.

- The commands used are the same as those for RS-232C. Refer to the communication procedure (see page 31) for operation.
- Usable commands are provided in the RS-232C command table (see page 33).

(3) Disconnect the connection with the monitor and quit the function.

1. Send [BYE Enter].

When the transmission is successful, [goodbye] is returned and the connection is disconnected.

TIPS

- Connection is automatically disconnected when the time specified in AUTO LOGOUT TIME elapses over a no-communication period.

Troubleshooting

If you are experiencing any problem with your display, before calling for service, please review the following troubleshooting tips.

There is no picture or sound.

- Is the power cord disconnected? (See page 13.)
- Is the main power switch off? (See page 17.)
- Is the monitor in standby mode (the power LED illuminating in orange)? (See page 17.)
- Make sure correct input mode is selected. (See page 19.)
- If any external equipment is connected, make sure the equipment is operating (playing back).

Remote control does not work.

- Are the batteries inserted with polarity (+,-) aligned? (See page 15.)
- Are the batteries exhausted?
- Point the remote control unit toward the monitor's remote control sensor. (See page 15.)
- Is the remote control operation in MONITOR LOCK of OTHERS menu enabled? (See page 29.)

Sound from left and right speakers is reversed.

Sound is heard from only one side.

- Are audio cables connected properly? (See page 12.)

There is a picture but no sound.

- Is the sound muted? (See page 18.)
- Make sure the volume is not set to minimum. (See page 18.)
- Are audio cables connected properly?
- When AUDIO OUTPUT is set to VARIABLE2 in the AUDIO menu, the speaker is muted. Check the setting. (See page 27.)

Unstable video.

- The signal may be incompatible. (See pages 43 and 44.)

The video from the HDMI input terminal does not appear properly.

- Is the HDMI cable HDMI standard compliant? The monitor will not work with cables that are not standard compliant.
- Is the input signal compatible with this monitor? (See pages 43 and 44.)

The video from DisplayPort input terminal does not appear correctly.

- Is the input signal compatible with this monitor? (See page 43.)
- Is the DisplayPort cable DisplayPort standard compliant? The monitor will not work with cables that are not standard compliant.

The video from D-sub input terminal does not appear correctly.

- Is the input signal compatible with this monitor? (See page 43.)

Video color is strange.

- Is the PICTURE menu setting correct? You can execute RESET to return to the factory default settings. (See page 26.)

Control buttons do not work.

There is no picture.

- Load noises from outside may be interfering with normal operation. Turn off the main power and turn it on after waiting at least 5 seconds, and then check the operation. (See page 17.)
- Turn on the monitor first before turning on the computer or playback device.

The input mode changes automatically.

- When the NO SIGNAL AUTO INPUT SEL. is ON and no signal is present in a selected input mode, the monitor automatically changes the selected mode to a mode where a video signal is present.

The input mode may change in the following cases:

- When a computer is in standby mode.
- When video play is stopped with a playback device.

The touch panel does not respond.

- Is the USB cable connected properly?
- Is the monitor in pen-only mode? Touch action is disabled in pen-only mode. (See page 19 and 21.)
- Is the monitor in finger-only mode? You cannot touch the screen with the touch pen when in finger-only mode. (See page 19 and 21.)
- If your finger is too dry, the screen may not respond.
- Do not touch the screen when the monitor power is turned on, it will lead to a malfunction. When this occurs, turn the monitor power off and then on.
- Use only the supplied USB cable. If the commercially available USB cable is used, the touch panel may not operate correctly.
If you want to position the monitor further away than the USB cable will allow, extend the cable using a USB cable with a repeater.
- When USB PORT SELECTION is OPTION, the touch panel cannot be used with the computer that is connected to this monitor.

When "AUTO DIMMING" is displayed.

- When the internal temperature of the monitor rises excessively, the brightness of the backlight automatically decreases in order to prevent a further temperature rise. If you attempt to adjust the brightness while the monitor is in this state, "AUTO DIMMING" is displayed and you cannot change the brightness.
- Remove the cause of the excessive temperature rise.

The monitor makes a cracking sound.

- You may occasionally hear a cracking sound from the monitor. This happens when the cabinet slightly expands and contracts according to change in temperature. This does not affect the monitor's performance.

Troubleshooting

The Power LED is flashing in red and green alternately. When "AUTO DIMMING" is displayed in the corner of the screen.

- When the internal temperature of the monitor rises excessively, the brightness of the backlight decreases automatically in order to prevent high-temperature-related problems. When this occurs, "AUTO DIMMING" is displayed on the screen and the Power LED flashes red and green alternately.
- If the internal temperature rises further, the monitor automatically enters standby mode. (The Power LED continues flashing red and green alternately.)
- Remove the cause of the excessive temperature rise.
 - If the monitor enters standby mode due to a rise in temperature, to return to normal display, turn the power switch off and then back on again. The monitor, however, will enter standby mode again if the cause of the temperature rise is not eliminated. (See page 7.)
 - Check whether the monitor is placed at a location where a quick rise in temperature is likely. Internal temperature rises quickly if the vents on the monitor are blocked.
 - Internal temperature rises quickly if dust accumulates inside the monitor or around the vents. Remove dust if possible. Ask SHARP dealer about removing internal dust.

The inner side of the glass is cloudy.

- When the humidity is high, the inner side of the glass may cloud after the power is turned on. The cloudiness is caused by the difference between the ambient temperature and the temperature of the air inside the glass, and is not a malfunction. You can continue to use the monitor to disappear the cloudiness.

Specifications

■Product Specifications

Model		PN-L401C
LCD component		40" Class [39-1/2 inch (100.33cm) diagonal] TFT LCD
Max. resolution	(pixels)	1920 x 1080
Max. colors		Approx. 16.77 million colors
Pixel pitch		0.45735 mm (H) × 0.4494 mm (V)
Max. brightness (typical) *1		210 cd/m ² (LCD panel : 300 cd/m ²)
Contrast ratio (typical)		5000 : 1
Viewing angle		178° right/left/up/down (contrast ratio ≥ 10)
Screen active area		inch (mm) 34-9/16 (W) x 19-1/8 (H) (878.112 x 485.352)
Computer input signal		Analog RGB (0.7 Vp-p) [75 Ω], HDMI, DisplayPort
Sync signal		Horizontal/vertical separate (TTL: positive/negative)
Plug and play		VESA DDC2B
Power management		VESA DPMS
Input terminals	Video	HDMI x 2 DisplayPort x 1 Mini D-sub 15 pin, 3 rows x 1
	Audio	3.5 mm mini stereo jack x 1
	Serial (RS-232C)	D-sub 9 pin x 1
Output terminals	Audio	3.5 mm mini stereo jack x 1
LAN terminal		10 BASE-T/100 BASE-TX
USB port		Type A (USB 2.0 compliant) x 2
Speaker output		10 W + 10 W
Touch Panel	Detection method	Capacitive type
	Computer connector	USB (2.0 compliant) (type B) x 1
Expansion slot		12 V, 2.5 A (power supplied when expanding the functions with an optional part)
Power requirement		AC 100 V - 240 V, 1.0 A, 50/60 Hz
Operating temperature *2 *3		41°F to 95°F (5°C to 35°C)
Operating humidity *3		20% to 80% (no condensation)
Power consumption (input signal waiting mode *4*5 / standby mode *6)		89 W (2 W/2 W)
Dimensions (excluding protrusions)		inch (mm) Approx. 36-15/16 (W) x 2-9/16 (D) x 21-1/2 (H) (939 x 65 x 546)
Weight		lbs. (kg) Approx. 38.6 (17.5)

*1 Brightness will depend on input mode and other picture settings. Brightness level will decrease over time. Due to the nature of the equipment, it is not possible to precisely maintain a constant level of brightness.

*2 When using the monitor laying flat on a surface (when the monitor is tilted more than 20 degrees upward from the perpendicular in relation to a level surface), use the monitor at a temperature between 41°F (5°C) and 86°F (30°C).
Temperature condition may change when using the monitor together with the optional equipments recommended by SHARP. In such cases, please check the temperature condition specified by the optional equipments.

*3 In addition, check the requirements of the computer and other devices to be connected, and make sure that all requirements are satisfied.

*4 When the optional part is not installed.

*5 When NO SIGNAL AUTO INPUT SEL. is set to OFF.

*6 When POWER SAVE MODE is set to OFF.

When POWER SAVE MODE is set to ON: 0.5 W

As a part of our policy of continuous improvement, SHARP reserves the right to make design and specification changes for product improvement without prior notice. The performance specification figures indicated are nominal values of production units. There may be some deviations from these values in individual units.

Specifications

■ Dimensional Drawings

Note that the values shown are approximate values.

Unit: inch [mm]

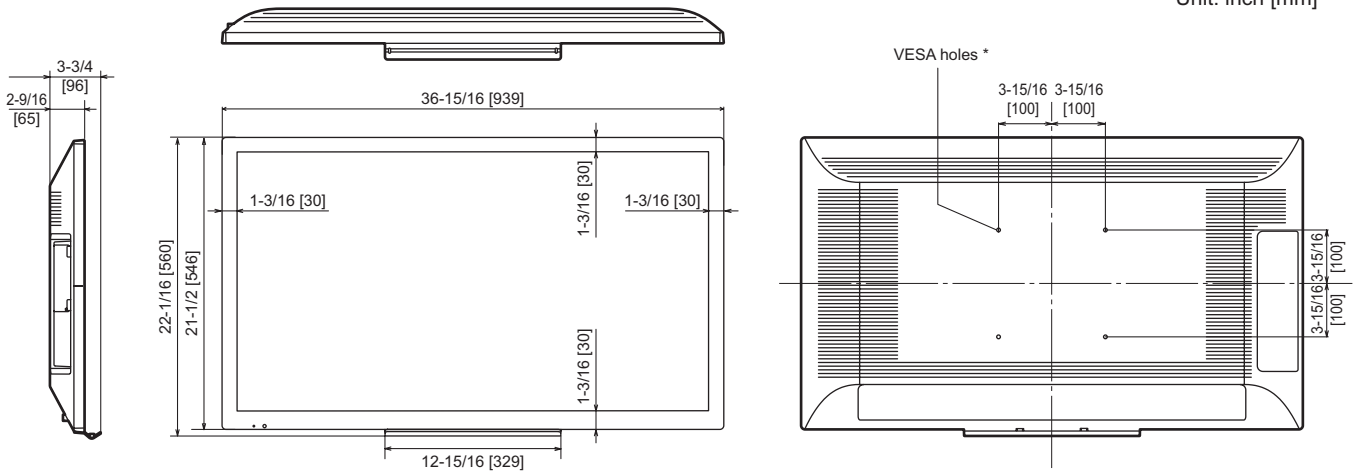

* When mounting the monitor, be sure to use a wall-mount bracket that complies with the VESA-compatible mounting method. SHARP recommends using M6 screws and tighten the screws. Note that screw hole depth of the monitor is 3/8 inch (10 mm). Loose mounting may cause the product to fall, resulting in serious personal injuries as well as damage to the product. The screw and hole should come together with over 5/16 inch (8 mm) length of thread. Use a bracket which has been approved for UL1678 standard, and which can endure at least 4 times or more the weight of the monitor.

Installation with the stand

Unit: inch [mm]

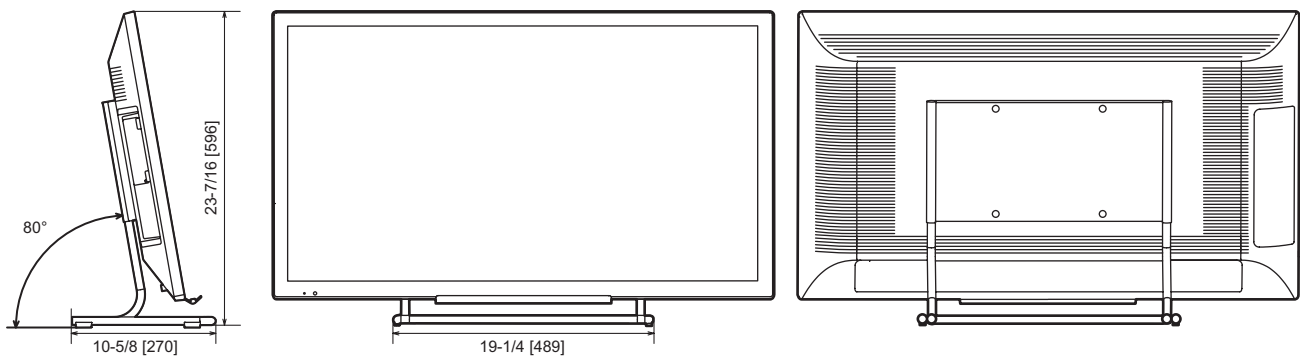

■Power management

This monitor conforms to VESA DPMS. Both your video card and computer must support the same standard in order for the monitor's power management function to work.

DPMS: Display Power Management Signaling

DPMS	Screen	Power consumption	Hsync	Vsync
ON STATE	Display	89 W	Yes	Yes
STANDBY	No display	2 W*	No	Yes
SUSPEND			Yes	No
OFF STATE			No	No

* When NO SIGNAL AUTO INPUT SEL. is set to OFF.

■DDC (plug and play)

The monitor supports the VESA DDC (Display Data Channel) standard.

DDC is a signal standard for plug and play between monitors and computers. Information about resolution and other parameters is exchanged between the two. This function can be used if the computer supports DDC and it has been configured to detect plug-and-play monitors.

There are several types of DDC, depending on the communication method used. This monitor supports DDC2B.

■Compatible signal timing (PC)

Screen resolution		Hsync	Vsync	Dot frequency	Digital		Analog (D-sub)
					DisplayPort	HDMI	
VESA	640 × 480	31.5kHz	60Hz	25.175MHz	-	-	Yes
		37.9kHz	72Hz	31.5MHz	-	-	Yes
		37.5kHz	75Hz	31.5MHz	-	-	Yes
	800 × 600	35.1kHz	56Hz	36.0MHz	-	-	Yes
		37.9kHz	60Hz	40.0MHz	-	-	Yes
		48.1kHz	72Hz	50.0MHz	-	-	Yes
		46.9kHz	75Hz	49.5MHz	-	-	Yes
	1024 × 768	48.4kHz	60Hz	65.0MHz	Yes	Yes	Yes
		56.5kHz	70Hz	75.0MHz	Yes	Yes	Yes
		60.0kHz	75Hz	78.75MHz	Yes	Yes	Yes
	1152 × 864	67.5kHz	75Hz	108.0MHz	Yes	Yes	Yes
	1280 × 800	49.7kHz	60Hz	83.5MHz	Yes	Yes	Yes
	1280 × 960	60.0kHz	60Hz	108.0MHz	Yes	Yes	Yes
	1280 × 1024	64.0kHz	60Hz	108.0MHz	Yes	Yes	Yes
		80.0kHz	75Hz	135.0MHz	Yes	Yes	Yes
	1360 × 768	47.7kHz	60Hz	85.5MHz	Yes	Yes	Yes
	1400 × 1050	65.3kHz	60Hz	121.75MHz	Yes	Yes	Yes
	1440 × 900	55.9kHz	60Hz	106.5MHz	Yes	Yes	Yes
	1600 × 1200 *	75.0kHz	60Hz	162.0MHz	Yes	Yes	Yes
1920 × 1200 *	74.0kHz	60Hz	154.0MHz	Yes	Yes	Yes	
Wide	1920 × 1080	67.5kHz	60Hz	148.5MHz	Yes	Yes	Yes
US TEXT	720 × 400	31.5kHz	70Hz	28.3MHz	Yes	Yes	Yes

* Displays a reduced image, except in Dot by Dot. In Dot by Dot, the image will be cut down to panel size then displayed.

- Depending on the connected computer, images may not be displayed properly even if the compatible signal described above is input.

Specifications

■Compatible signal timing (AV)

Screen resolution	Frequency	HDMI
1920 × 1080p	50Hz	Yes
	60Hz	Yes
1920 × 1080i	50Hz	Yes
	60Hz	Yes
1280 × 720p	50Hz	Yes
	60Hz	Yes
720 × 576p	50Hz	Yes
720 × 480p	60Hz	Yes
720(1440) × 576i	50Hz	Yes
720(1440) × 480i	60Hz	Yes

■D-sub input terminal pins

(Mini D-sub 15 pin)

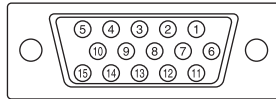

No.	Function	No.	Function
1	Red video signal input	9	+5V
2	Green video signal input	10	GND
3	Blue video signal input	11	N.C.
4	N.C.	12	DDC data
5	GND	13	Hsync signal input
6	GND for red video signal	14	Vsync signal input
7	GND for green video signal	15	DDC clock
8	GND for blue video signal		

■HDMI input terminal pins

(HDMI™ Connector)



No.	Function	No.	Function
1	TMDS data 2+	11	TMDS clock shield
2	TMDS data 2 shield	12	TMDS clock-
3	TMDS data 2-	13	CEC
4	TMDS data 1+	14	N.C.
5	TMDS data 1 shield	15	SCL
6	TMDS data 1-	16	SDA
7	TMDS data 0+	17	DDC/CEC GND
8	TMDS data 0 shield	18	+5V
9	TMDS data 0-	19	Hot-plug detection
10	TMDS clock+		

■DisplayPort input terminal pins

(DisplayPort 20 pin)

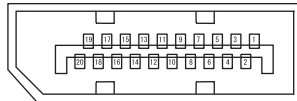

No.	Function	No.	Function
1	MainLane 3-	11	Gnd
2	Gnd	12	MainLane 0+
3	MainLane 3+	13	Gnd
4	MainLane 2-	14	Gnd
5	Gnd	15	Aux +
6	MainLane 2+	16	Gnd
7	MainLane 1-	17	Aux -
8	Gnd	18	Hot-plug detection
9	MainLane 1+	19	Gnd
10	MainLane 0-	20	3.3V

Information on the software license for this product

■Software composition

The software included in this product is comprised of various software components whose individual copyrights are held by SHARP or by third parties.

This product also makes use of freely distributed software and software components whose copyrights are held by third parties.

■Software copyrights

The copyrights of some software components incorporated in the monitor require that the license be displayed. The licenses of these software components are shown below.

uIP Embedded TCP/IP Stack

Copyright (c) 2001-2006, Adam Dunkels.

Copyright (c) 2004-2006, Swedish Institute of Computer Science.

All rights reserved.

Redistribution and use in source and binary forms, with or without modification, are permitted provided that the following conditions are met:

1. Redistributions of source code must retain the above copyright notice, this list of conditions and the following disclaimer.
2. Redistributions in binary form must reproduce the above copyright notice, this list of conditions and the following disclaimer in the documentation and/or other materials provided with the distribution.
3. Neither the name of the Institute nor the names of its contributors may be used to endorse or promote products derived from this software without specific prior written permission.

THIS SOFTWARE IS PROVIDED BY THE INSTITUTE AND CONTRIBUTORS "AS IS" AND ANY EXPRESS OR IMPLIED WARRANTIES, INCLUDING, BUT NOT LIMITED TO, THE IMPLIED WARRANTIES OF MERCHANTABILITY AND FITNESS FOR A PARTICULAR PURPOSE ARE DISCLAIMED. IN NO EVENT SHALL THE INSTITUTE OR CONTRIBUTORS BE LIABLE FOR ANY DIRECT, INDIRECT, INCIDENTAL, SPECIAL, EXEMPLARY, OR CONSEQUENTIAL DAMAGES (INCLUDING, BUT NOT LIMITED TO, PROCUREMENT OF SUBSTITUTE GOODS OR SERVICES; LOSS OF USE, DATA, OR PROFITS; OR BUSINESS INTERRUPTION) HOWEVER CAUSED AND ON ANY THEORY OF LIABILITY, WHETHER IN CONTRACT, STRICT LIABILITY, OR TORT (INCLUDING NEGLIGENCE OR OTHERWISE) ARISING IN ANY WAY OUT OF THE USE OF THIS SOFTWARE, EVEN IF ADVISED OF THE POSSIBILITY OF SUCH DAMAGE.

SIL Open Font License

"Noto Mono" and "Noto Sans CJK JP"

licensed under the SIL Open Font License <http://www.google.com/get/noto/#/>

Mounting Precautions (For SHARP dealers and service engineers)

- When installing, removing or moving the monitor, ensure that this is carried out by at least 2 people.
- Be sure to use a wall-mount bracket designed or designated for mounting the monitor.
- This monitor is designed to be installed on a concrete wall or pillar. Reinforced work might be necessary for some materials such as plaster / thin plastic board / wood before starting installation.
This monitor and bracket must be installed on a wall which can endure at least 4 times or more the weight of the monitor.
Install by the most suitable method for the material and the structure.
- To attach a VESA-compliant mounting bracket, use M6 screws that are 5/16 inch (8 mm) to 3/8 inch (10 mm) longer than the thickness of the mounting bracket.

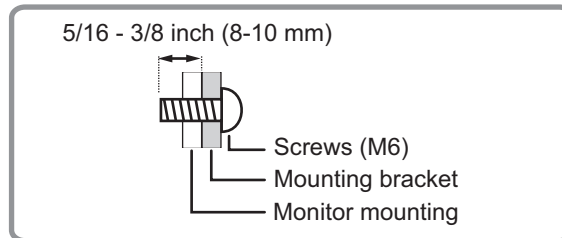

- Do not use an impact driver.
- After mounting, please carefully ensure the monitor is secure, and not able to come loose from the wall or mount.
- Do not use any screw holes other than VESA holes for installation.
- When moving the monitor, be sure to hold it around the periphery. Do not grasp the screen or tray. This may cause product damage, failure, or injury.
- If you need to temporarily place the monitor on a table or other surface during installation, spread a thick soft cloth on the table to prevent damage to the screen and table.
- Prior to repacking or removal, remove the tray and speaker covers.

■Attaching the Tray

Secure the tray using 2 tray mounting screws (M3) (supplied).

Landscape orientation

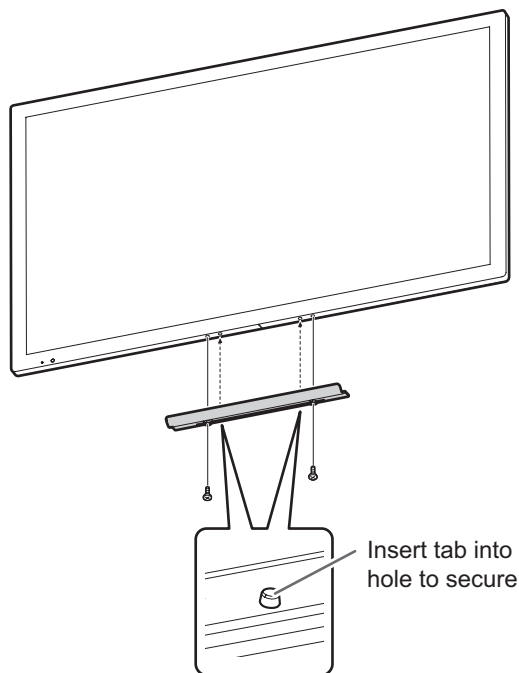

Portrait orientation

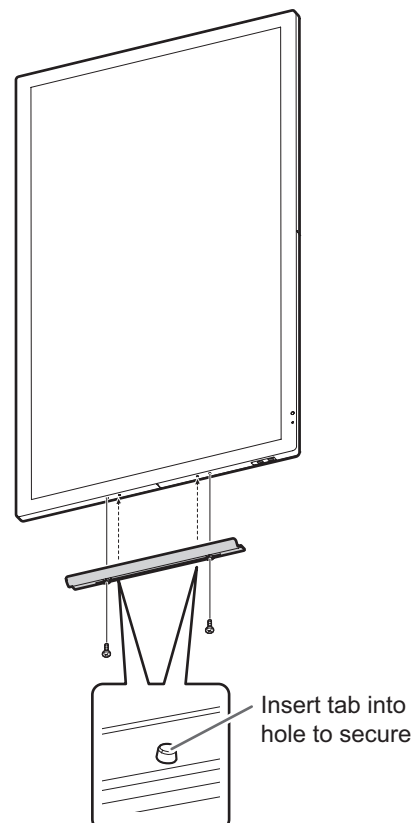

Mounting Precautions (For SHARP dealers and service engineers)

■ Attach the stand to the monitor

! Caution

- The stand is for use in landscape orientation. It cannot be used for portrait orientation.

1. Attach the stand rods (x2) to the VESA angle.

Put the VESA angle with the screw holes face up as below. Attach the stand rods to the VESA angle, and secure it with 4 stand mounting screws (M3).

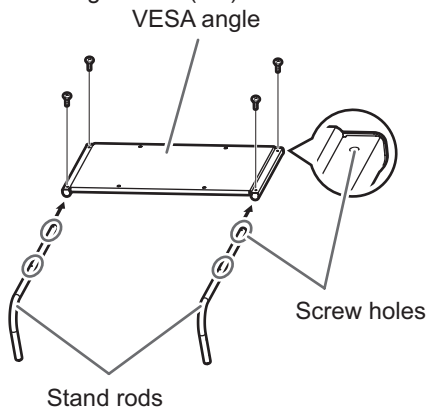

2. Attach the stand leg to the stand rods.

Flip the VESA angle and secure the stand rods and the ends of stand leg with 4 stand mounting screws (M4).

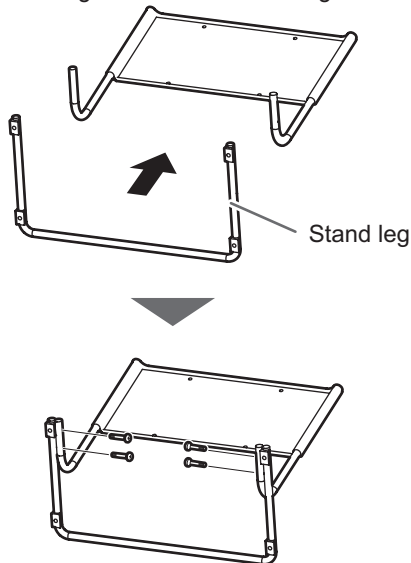

3. Spread a thick, soft cloth (blanket, etc.) that will prevent damage to the LCD panel on a stable flat surface where the entire monitor can be placed, and place the monitor with the LCD panel face down on the cloth.

Place so that the bottom of the monitor comes to the edge of the table.

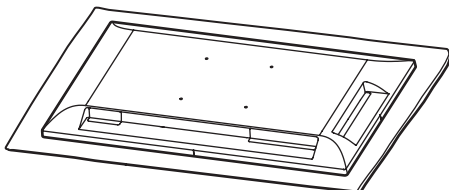

4. Attach the stand to the monitor.

Secure from the back with 4 stand mounting screws (M6).

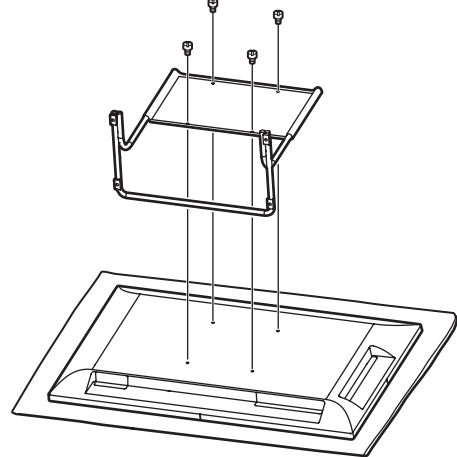

■ Disassembling the stand

1. Spread a thick, soft cloth (blanket, etc.) that will prevent damage to the LCD panel on a stable flat surface where the entire monitor can be placed, and place the monitor with the LCD panel face down on the cloth.
2. Remove the screws(x4) that fasten the attachment plate, and remove the attachment plate.

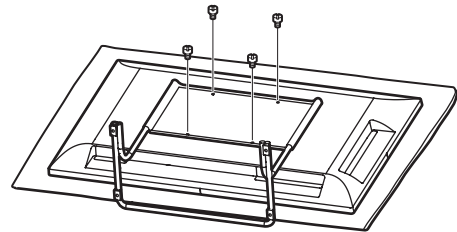

3. Reverse the stand assembly procedure to disassemble the stand.

SHARP[®]
SHARP CORPORATION